



# NEPTUNE X-PRO FULL INVERTER HEAT PUMP



## INSTALLATION GUIDE AND USER MANUAL

THANK YOU FOR PURCHASING A NEPTUNE FULL INVERTER HEAT PUMP.  
Please read the manual thoroughly before installing or using the product.  
Only qualified technicians must install the product. Keep this manual for future reference.



# TABLE OF CONTENTS

	Page
<b>SECTION 1: IMPORTANT WARNINGS AND SAFETY INFORMATION</b> .....	4-5
<b>SECTION 2: TRANSPORT, STORAGE AND HANDLING</b> .....	5
<b>SECTION 3: PACKAGING CONTENTS</b> .....	5
<b>SECTION 4: PRODUCT SPECIFICATIONS</b> .....	6-8
4.1: PRODUCT DIMENSIONS .....	6
4.2: TECHNICAL DATA .....	7-8
4.3: OPERATING CONDITIONS .....	8
<b>SECTION 5: INSTALLATION</b> .....	8-20
5.1: IMPORTANT INSTALLATION INFORMATION .....	8
5.2: POSITIONING AND LOCATION OF THE HEAT PUMP .....	9
5.3: INSTALLATION OF THE HEAT PUMP .....	9-11
5.4: FLOW VALVE POSITIONS .....	12
5.5: WIRING OF THE HEAT PUMP .....	13-14
5.6: WIRING DIAGRAM: SINGLE PHASE 230V 50Hz .....	14
5.7: WIRING DIAGRAM: 3 PHASE 400V 50Hz .....	14
5.8: WIRING DIAGRAM FOR EXTREME WINTER CONDITIONS: SINGLE PHASE 230V ≤500W .....	15
5.9: WIRING DIAGRAM FOR EXTREME WINTER CONDITIONS: SINGLE PHASE 230V >500W .....	16
5.10: WIRING DIAGRAM FOR EXTREME WINTER CONDITIONS: 3 PHASE 400V .....	17
5.11: PARALLEL CONNECTION WITH FILTRATION CLOCK .....	18
5.12: CONNECTING THE NEPTUNE HEAT PUMP CONTROLLER .....	18-20
<b>SECTION 6: INITIAL START-UP</b> .....	21
6.1: PRE-STARTUP INSPECTION .....	21
6.2: INITIAL STARTUP .....	21
<b>SECTION 7: OPERATING INSTRUCTIONS</b> .....	22-28
7.1: IMPORTANT OPERATING INFORMATION .....	22
7.2: HEAT PUMP TOUCHPAD OVERVIEW .....	23
7.3: HEAT PUMP LCD SCREEN OVERVIEW .....	24
7.4: STANDBY MODE .....	24
7.5: TURNING ON THE HEAT PUMP .....	24
7.6: SETTING THE TEMPERATURE .....	24
7.7: SETTING THE HEATING/COOLING MODE .....	24
7.8: SETTING THE SPEED (TURBO/SMART/SILENCE MODE) .....	25
7.9: VIEWING REAL-TIME POWER CONSUMPTION OR COMPRESSOR PERCENTAGE .....	25
7.10: CHANGING TEMPERATURE BETWEEN °C AND °F .....	25
7.11: SETTING THE CLOCK (TIME OF DAY) .....	26
7.12: VIEWING THE TIME OF DAY .....	26
7.13: SETTING THE TIMER (RUN TIMES OF THE HEAT PUMP) .....	26-27
7.14: DEFROSTING .....	28
7.15: USING THE HEAT PUMP COVER .....	28
<b>SECTION 8: WIFI SETUP</b> .....	28-33
8.1: APP DOWNLOAD AND ACCOUNT REGISTRATION .....	28-29
8.2: PAIRING YOUR DEVICE WITH THE HEAT PUMP VIA AUTO-DISCOVERY/BLE .....	29
8.3: PAIRING YOUR DEVICE WITH THE HEAT PUMP VIA MANUALLY ADDING .....	30
8.4: PAIRING YOUR DEVICE WITH THE HEAT PUMP VIA AP MODE .....	31
8.5: RE-PAIRING YOUR DEVICE .....	32
8.6: APP FEATURES .....	32
8.7: SHARE DEVICES WITH FAMILY MEMBERS .....	33
8.8: CREATE A FAMILY .....	33
<b>SECTION 9: MAINTENANCE</b> .....	34
9.1: REGULAR MAINTENANCE .....	34
9.2: ANNUAL MAINTENANCE – QUALIFIED TECHNICIAN ONLY .....	34
<b>SECTION 10: WINTERISING</b> .....	34-35
<b>SECTION 11: TROUBLESHOOTING</b> .....	35-36
<b>SECTION 12: SCHEMATICS – NHX10, NHX11, NHX13, NHX14, NHX17, NHX18, NHX21, NHX22, NHX26, NHX32..</b>	37-38
<b>SECTION 13: SCHEMATICS – NHX323, NHX403</b> .....	39-40
<b>SECTION 14: WARRANTY &amp; PRODUCT REGISTRATION</b> .....	41

## **SECTION 1: IMPORTANT WARNINGS AND SAFETY INFORMATION**



This manual contains important information about the installation, operation, and safe use of this product. This information should be given to the owner and/or operator of the heat pump. When installing and using the heat pump, basic safety precautions should always be followed. Failure to follow safety warnings and instructions in this manual can result in serious injury and/or damage to your equipment. Read and follow all warning notices and instructions which are included in this manual.



**This Full Inverter Heat Pump contains R32 refrigerant gas which is a flammable substance under certain conditions.**

### **GENERAL WARNINGS**

- Read the instructions before installing and using the heat pump.
- Failure to follow these instructions and comply with all applicable codes may cause serious bodily injury and/or property damage and will void the warranty.
- Installers/operators must follow manufacturer's instructions and keep in compliance with national or local standards for installation. Under no circumstances will the manufacturer be held responsible for any outcome incurred by failure to comply with applicable standards or local regulations.
- Turn off the power during thunderstorms and severe weather.
- Do not use or store combustible gas or liquid such as thinners, paint or fuel near the heat pump.
- Always keep the heat pump in the upright position especially when storing or moving the heat pump.
- The heat pump is designed for heating swimming pools; do not use it for any other purpose.
- The surroundings of the heat pump must be kept clear to avoid restricting ventilation.
- The heat pump must be kept away from any source of fire.
- Do not put anything into the inlet or outlet, and do not remove the fan cover.
- This product contains electrical equipment. Dispose of the product in accordance with local regulations.

### **INSTALLATION, SERVICE AND MAINTENANCE WARNINGS**

- **Ensure that there is adequate voltage and current available at the heater connection to run the unit. Voltage ranges outside of the required parameters will damage the heat pump and void the warranty.**
- **Always use a qualified electrician to perform any electrical work. A licenced electrician must read these instructions before installing.**
- Gas leakage tests must be done before and after installation.
- Installation, removal and service of the heat pump must be handled by a professional pool builder/service agent. Repairs should be carried out in a well ventilated area.
- The heat pump must be positioned on a concrete base.
- The frame must be secured using M10 bolts. Frame/brackets must be of a suitable strength and anti-rust treated.
- Do not lift the heat pump using the water unions.
- The heat pump must be installed in a well ventilated, outside area.
- Ensure power is disconnected during installation or service.
- Stop installation if there is any gas leakage. The unit must be returned to the authorised dealer.
- Vacuum completely before welding. Field welding is not allowed.
- Always comply with the national and local electrical codes and standards.
- Ensure electrical cable size is adequate for heater requirements at the installation location.
- Earth/ground the heat pump to protect yourself against short circuits inside the unit.
- Ensure the power cable and circuit breaker are of suitable size for the heat pump being installed.
- To ensure heating efficiency, the water pipe length should be 10m or less between the pool and the heat pump.
- Hard/rigid plumbing must be used for the inlet and outlet water unions.
- The heat pump must be maintained/serviced by a qualified professional.
- The main power switch should be out of the reach of children.
- Use only genuine replacement parts supplied by the manufacturer for service and repair.
- Do not try to repair the heat pump yourself or open the casing. In case of malfunction, switch off the main power immediately and contact your authorised dealer.

## **DISCLAIMER**

Information in this manual is intended to provide general information on a particular subject(s) in good faith and is not an exhaustive treatment of such subject(s). Its use is beyond the control of the author, contributor, publishers, and distributors and should not be relied upon without consulting your local Professional for comprehensive advice. This manual includes subject(s) that should only be performed by or under the direction and advice of your local Professional and under no circumstances should the manual be used as a substitute for such professionals. No representations or warranties are made that the content, advice, and recommendations in this manual are current, free from errors or omissions, or appropriate for the user's circumstances or abilities. No liability is accepted for any loss suffered as a result of any user's reliance on such content. All information in this document is subject to change at any time without notice.

## **SECTION 2: TRANSPORT, STORAGE AND HANDLING**

- Sealing is not allowed during transportation.
- Transporting goods at a constant speed is needed to avoid sudden acceleration or sudden braking, so as to reduce the collision of goods.
- The unit must be kept away from any source of fire.
- The heat pump must be stored in a bright, wide and open space with adequate ventilation.
- Do not lift the heat pump using the water unions.
- Do not use or store combustible gas or liquid such as thinners, paint and fuel near the heat pump.
- Always keep the heat pump in the upright position especially when storing or moving the heat pump.

## **SECTION 3: PACKAGING CONTENTS**

The following items are included in the packaging of the heat pump. Please contact your authorised dealer if any items are damaged or missing.

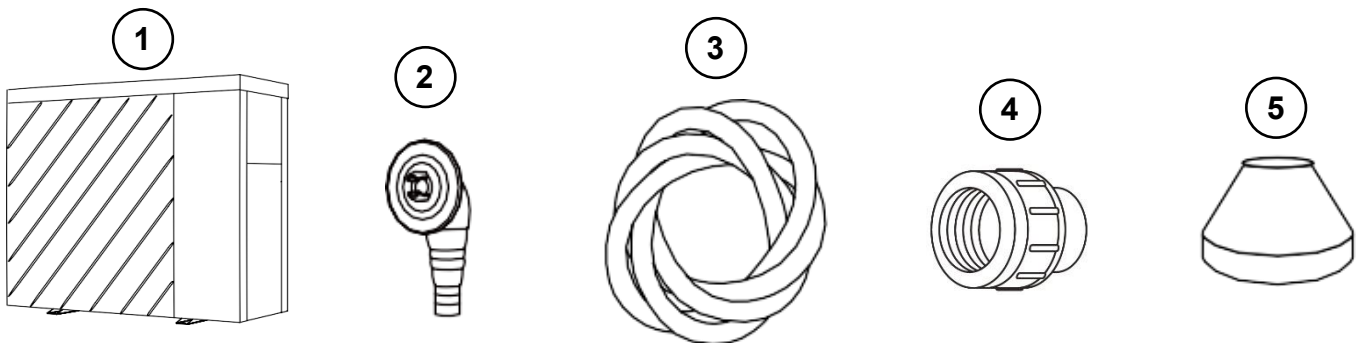

- (1) Heat Pump x 1
- (2) Drain Plug x 1
- (3) Drain Hose x 1
- (4) Unions x 2
- (5) Rubber Foot x 4
- (6) Bolt Assembly x 4
- (7) User Manual x 1
- (8) PVC Pipe Sticker Sheet x 1
- (9) Cover x 1

# SECTION 4: PRODUCT SPECIFICATIONS

## 4.1: PRODUCT DIMENSIONS

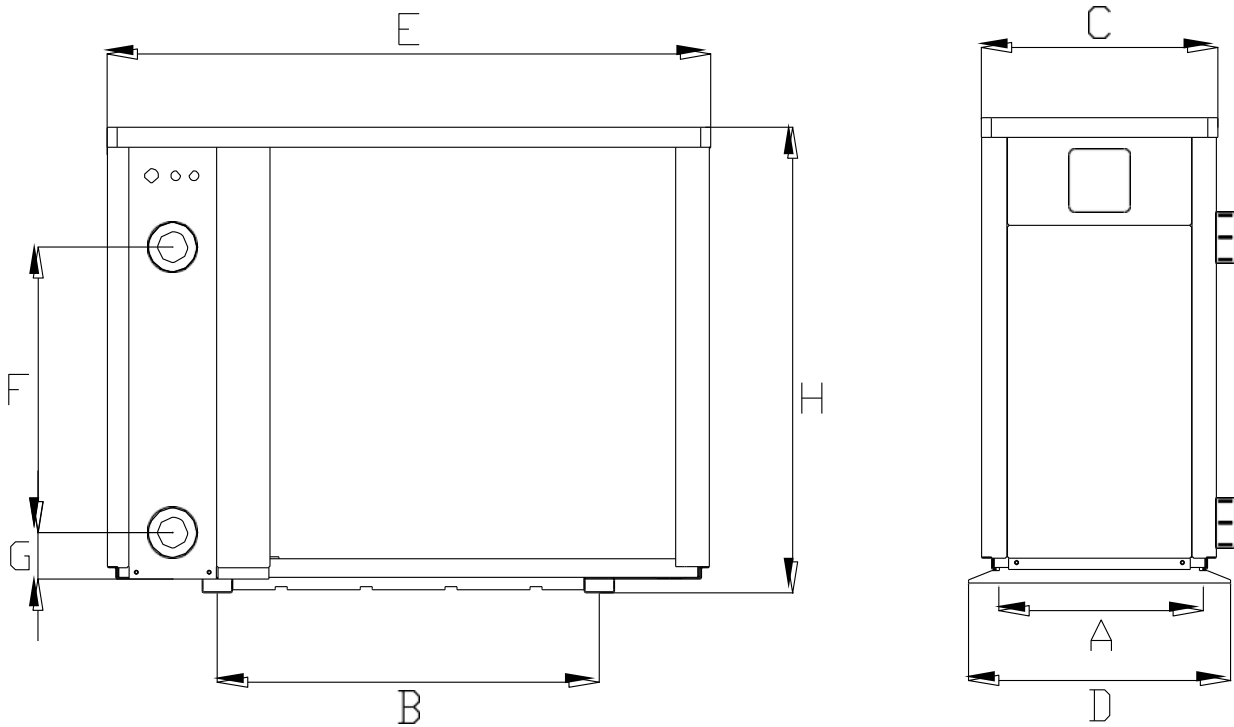

	UNITS (mm)	A	B	C	D	E	F	G	H
<b>MODEL</b>	NHX10	407	434	390	432	799	300	74	650
	NHX11	407	434	390	432	799	300	74	650
	NHX13	407	528	390	432	893	280	74	650
	NHX14	407	528	390	432	893	280	74	650
	NHX17	407	574	390	432	939	350	74	650
	NHX18	407	574	390	432	939	350	74	650
	NHX21	407	630	390	432	995	460	74	750
	NHX22	407	630	390	432	995	460	74	750
	NHX26	404	760	384	429	1125	600	74	952
	NHX32	514	710	493	539	1074	640	74	947
	NHX323	514	710	493	539	1074	640	74	947
	NHX403	514	900	493	539	1264	650	74	947
	NOTE: This data is subject to change without notice.								

## 4.2: TECHNICAL DATA

Model	NHX10	NHX11	NHX13	NHX14	NHX17	NHX18	NHX21	NHX22	NHX26	NHX32	NHX323	NHX403
Advised pool volume (L)	20,000 - 40,000	25,000 - 40,000	25,000 - 50,000	31,000 - 50,000	30,000 - 60,000	14,000 - 60,000	40,000 - 75,000	51,000 - 75,000	61,000 - 85,000	76,000 - 110,000	76,000 - 110,000	86,000 - 140,000
Working air temp (°C)	-15~43											
<b>Performance Condition: Air 26°C, Water 26°C, Humidity 80%</b>												
Heating capacity (kW) in Smart mode	8.5	9.2	11.0	11.5	13.8	14.5	17.5	17.8	21.5	27.0	27.0	35.0
Heating capacity (kW) in Turbo mode	10.2	11.0	13.2	13.5	16.8	17.5	21.0	21.5	25.5	31.5	31.5	40.0
C.O.P in Smart mode	7.8	7.8	8.2	8.2	7.5	7.5	7.3	7.3	7.8	7.4	7.4	7.3
C.O.P	15.1~7.1	15.1~7.1	15.0~7.3	15.0~7.3	15.5~6.4	15.5~6.4	15.0~6.3	15.0~6.3	16.0~6.8	15.8~6.3	15.8~6.3	15.8~6.4
C.O.P at 50% capacity	11.4	11.4	11.6	11.6	11.2	11.2	11.2	11.2	11.3	11.2	11.2	11.1
<b>Performance Condition: Air 15°C, Water 26°C, Humidity 70%</b>												
Heating capacity (kW) in Smart mode	6.3	6.3	7.3	7.5	9.4	9.4	11.8	11.8	14.8	18.0	18.0	24.0
Heating capacity (kW) in Turbo mode	7.5	7.5	8.8	9.0	11.3	11.3	14.3	14.3	17.5	21.5	21.5	28.0
C.O.P in Smart mode	5.2	5.2	5.3	5.3	5.0	5.0	5.0	5.0	5.4	5.3	5.3	5.1
C.O.P	6.9~4.8	6.9~4.8	6.8~4.9	6.8~4.9	7.3~4.4	7.3~4.4	7.8~4.6	7.8~4.6	7.8~4.9	7.8~4.9	7.8~4.9	7.9~4.7
C.O.P at 50% capacity	6.5	6.5	6.5	6.5	6.6	6.6	6.8	6.8	6.8	6.8	6.8	6.7
<b>Performance Condition: Air 35°C, Water 28°C, Humidity 80%</b>												
Cooling capacity (kW)	4.4	4.4	5.6	5.6	6.5	6.5	8.0	8.0	11.6	13.6	13.6	16.0
Sound pressure at 1m dB(A)	38.5~45.5	38.5~45.5	38.6~46.9	38.6~46.9	42.0~47.7	42.0~47.7	42.9~50.8	42.9~50.8	40.8~51.2	43.3~51.9	43.3~51.9	42.5~51.7
Sound pressure of 50% capacity at 1m dB(A)	39.5	39.5	41.3	41.3	43.7	43.7	44.5	44.5	44.4	46.4	46.4	43.8
Sound pressure at 10m dB(A)	18.5~25.5	18.5~25.5	18.6~26.9	18.6~26.9	22.0~27.7	22.0~27.7	22.9~30.8	22.9~30.8	20.8~31.2	23.3~31.9	23.3~31.9	22.5~31.7
Power supply	230V/1 Ph/50Hz										400V/3 Ph/50Hz	
Rated input power (kW) at air temperature 15°C	0.18~1.53	0.18~1.53	0.22~1.8	0.22~1.8	0.26~2.56	0.26~2.56	0.31~3.08	0.31~3.08	0.38~3.53	0.46~4.4	0.46~4.4	0.60~5.94
Rated input current (A) at air temperature 15°C	0.78~6.65	0.78~6.65	0.96~7.82	0.96~7.82	1.14~11.3	1.14~11.3	1.35~13.4	1.35~13.4	1.65~15.3	2.01~19.1	0.66~6.35	0.87~8.57
Max input current (A)	10.0	10.0	12.5	12.5	16.0	16.0	18.5	18.5	20.5	25.0	10	12.5
PVC Pipe I.D (mm)	40											
Pool pump water flow (L/min)	33~67	33~67	50~67	50~67	67~100	67~100	108~142	108~142	133~167	167~200	167~200	200~300
Pool pump max. head (m)	10											
Net Dimension LxWxH (mm)	799x432x650	799x432x650	893x432x650	893x432x650	939x432x650	939x432x650	995x432x750	995x432x750	1125x429x952	1074x539x947	1074x539x947	1260x539x947
Net Weight (kg)	51	51	61	61	65	65	70	70	98	102	111	126

The values indicated are valid under ideal conditions: pool covered with an isothermal cover, filtration system running at least 15 hours a day. Related parameters subject to adjustment periodically for technical improvement without further notice. For details please refer to nameplate.



MODEL		NHX10	NHX11	NHX13	NHX14	NHX17	NHX18	NHX21	NHX22	NHX26	NHX32	NHX323	NHX403
Breaker	Rated Current (A)	12.0	12.0	15.0	15.0	19.0	19.0	22.5	22.5	24.5	30.0	12.0	15.0
	Rated Residual Action Current (mA)	30	30	30	30	30	30	30	30	30	30	30	30
Max input current(A)		10.0	10.0	12.5	12.5	16.0	16.0	18.5	18.5	20.5	25.0	10.0	12.5
Power Supply		230V 50Hz	230V 50Hz	230V 50Hz	230V 50Hz	230V 50Hz	230V 50Hz	230V 50Hz	230V 50Hz	230V 50Hz	230V 50Hz	400V 50Hz	400V 50Hz
Fuse (A)		12.0	12.0	15.0	15.0	19.0	19.0	22.5	22.5	24.5	30.0	12.0	15.0
Power Cord (mm2)		3x2.5	3x2.5	3x2.5	3x2.5	3x2.5	3x2.5	3x2.5	3x2.5	3x4	3x6	5x2.5	5x2.5
Signal cable (mm2)		3x0.5	3x0.5	3x0.5	3x0.5	3x0.5	3x0.5	3x0.5	3x0.5	3x0.5	3x0.5	3x0.5	3x0.5

### 4.3: OPERATING CONDITIONS

ITEMS		RANGE
Operating Range	Ambient Air Temperature*	-15°C – 43°C
Temperature Setting	Heating	6°C – 40°C
	Cooling	6°C – 30°C

\*Ideal ambient air temperature is 15°C – 25°C.

## SECTION 5: INSTALLATION

### 5.1: IMPORTANT INSTALLATION INFORMATION

- **Ensure that there is adequate voltage and current available at the heater connection to run the unit. Voltage ranges outside of the required parameters will damage the heat pump and void the warranty.**
- **Always use a qualified electrician to perform any electrical work. A licenced electrician must read these instructions before installing.**
- The heat pump must be installed in a well ventilated, outside area with sufficient space for installation and maintenance.
- Gas leakage tests must be done before and after installation.
- The heat pump must be positioned on a concrete base.
- The frame must be secured using M10 bolts. Frame/brackets must be of a suitable strength and anti-rust treated.
- Do not lift the heat pump using the water unions.
- Ensure power is disconnected during installation or service.
- Installation must be stopped if there is any gas leakage, and the unit must be returned to the authorised dealer.
- Vacuum completely before welding. Field welding is not allowed.
- Always comply with the national and local electrical codes and standards.
- Ensure electrical cable size is adequate for heater requirements at the installation location.
- A licenced electrician must read these instructions before installing.
- Earth/ground the heat pump to protect yourself against short circuits inside the unit.
- Ensure the power cable and circuit breaker are of suitable size for the heat pump being installed.
- To ensure heating efficiency, the water pipe length should be 10m or less between the pool and the heat pump.
- The inlet and outlet water unions cannot bear the weight of soft/flexible plumbing. Hard/rigid plumbing must be used.
- The main power switch should be out of the reach of children.



## 5.2: POSITIONING AND LOCATION OF THE HEAT PUMP

The heat pump must be installed in accordance with the following diagrams. Distances in the diagram are the minimum distance allowed. The heat pump must be positioned on solid level ground (concrete slab) outdoors in a place with good ventilation. Do not install the heat pump in an enclosed area. Ensure there is sufficient access space for installation and maintenance.

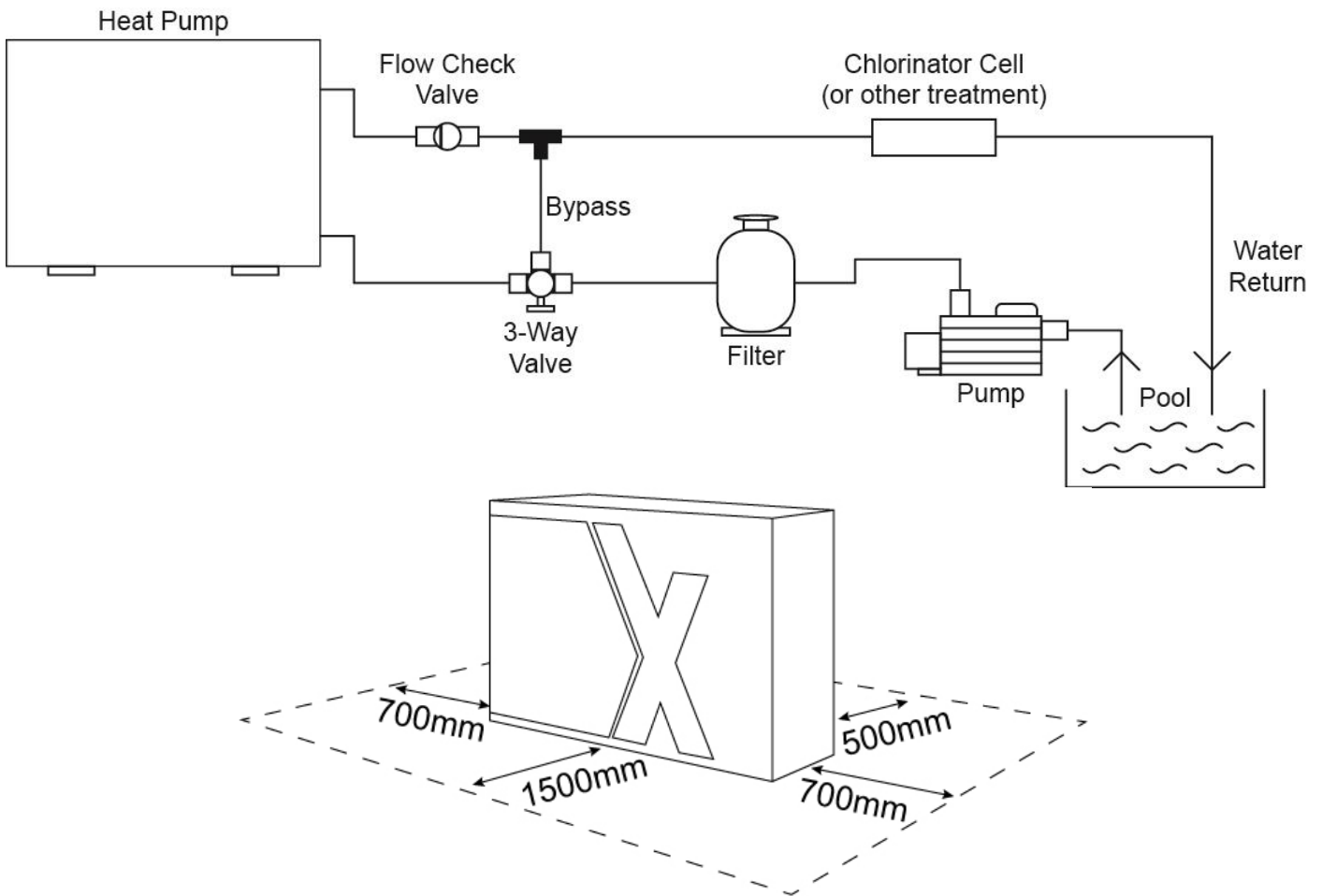

## 5.3: INSTALLATION OF THE HEAT PUMP

1. Install the 4 rubber feet onto the heat pump's legs, using the supplied bolts.

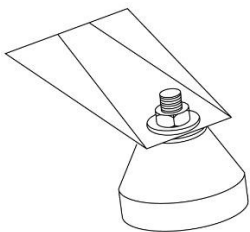

2. Install the drain plug into the drain hose, then attach the drain plug to the drain hole underneath the heat pump.

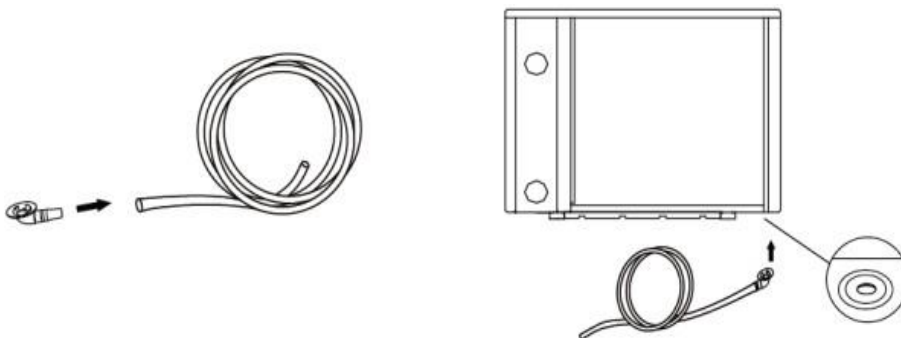

3. Run the drain hose downhill to a suitable location, for example a garden or nearby stormwater drain. When the heat pump is running, there will be condensation water discharged from the drain hose.
4. Ensure the heat pump is equipped with a circuit breaker and electrical isolator switch.
5. The heat pump requires a pool pump (supplied by the user). Refer to the Specifications Table in Section 4.2 for recommended pump water flow and maximum head information for the model being installed.
6. Install the unions as follows:

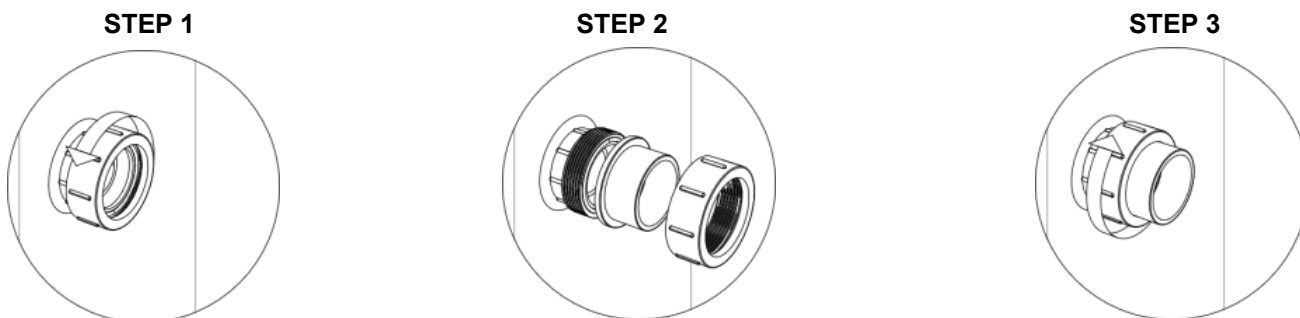

7. Connect the inlet downstream, after the pool pump and filter.

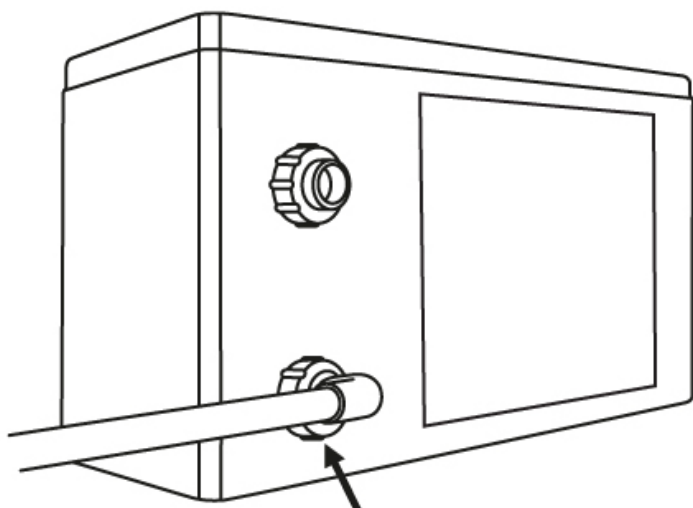

8. Connect the outlet upstream before chlorinator, acid injection or other chemical dosing systems.

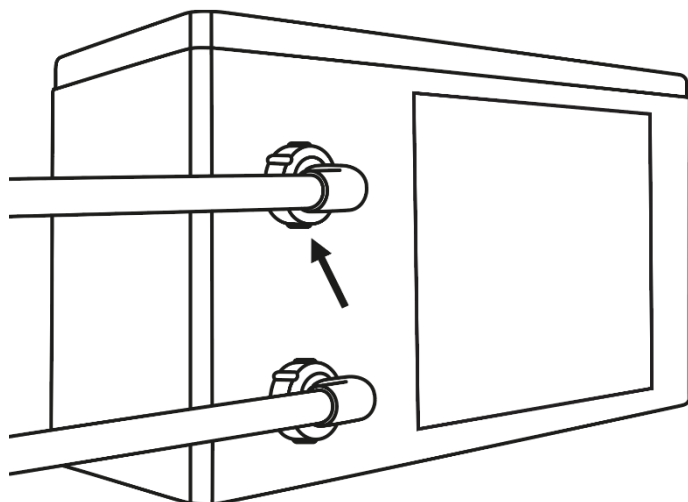

9. Create a flow bypass between the inlet and outlet pipework.

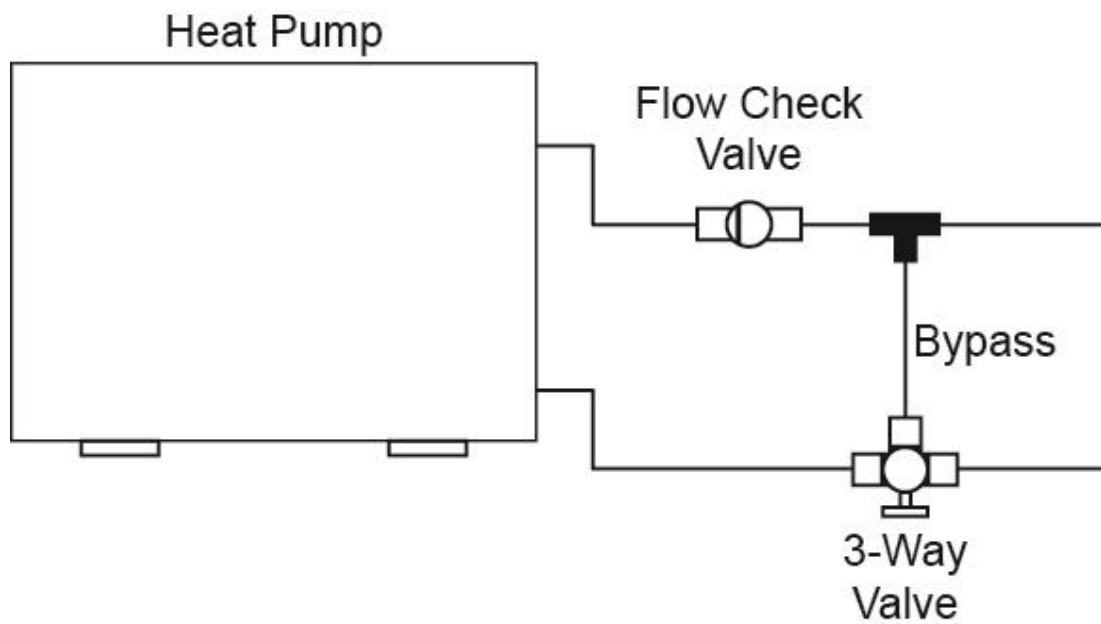

## 5.4: FLOW VALVE POSITIONS

**5.4.1:**  
100% FULL FLOW TO HEAT PUMP  
AND RETURN TO POOL

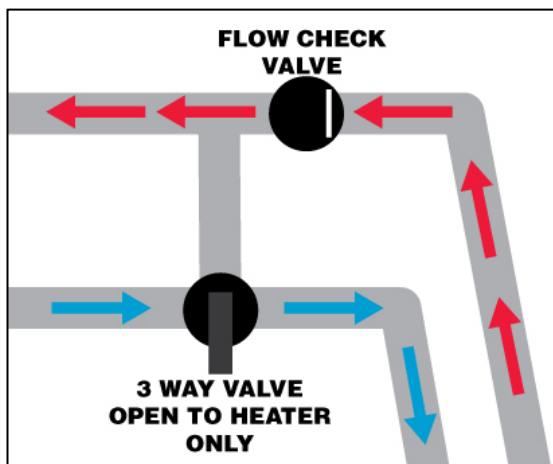

**5.4.2:**  
NO FLOW THROUGH HEAT PUMP  
Used to bypass heat pump, during heavy chemical dosing and maintenance/service of heat pump.

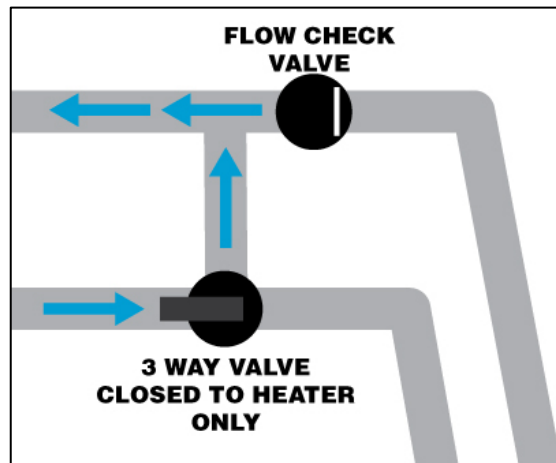

**5.4.3:**  
RESTRICTED WATER FLOW TO HEAT PUMP  
Used to reach the temperature differential between the inlet and outlet.

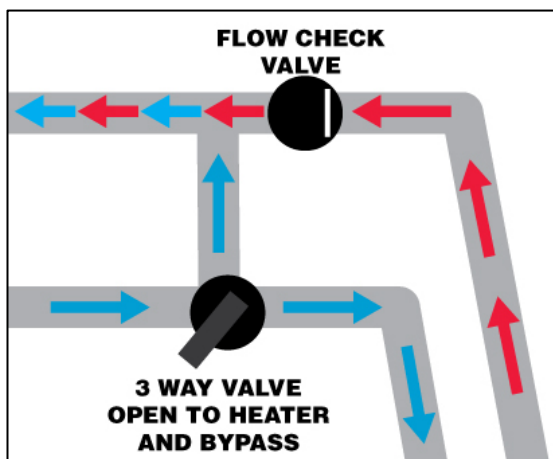

## 5.5: WIRING OF THE HEAT PUMP

1. Always use a qualified electrician to perform any electrical work. A licenced electrician must read these instructions before installing.
2. Wiring must be connected by a qualified professional electrician, according to the details set out in this manual.
3. The heat pump must be hard wired.
4. Ensure power is disconnected during installation or service. Always comply with the national and local electrical codes and standards. Ensure electrical cable size is adequate for heater requirements at the installation location.
5. The layout of power and signal cables should be neat and orderly. Considering environmental conditions (ambient temperature, direct sunlight, rain, grid voltage, cable length etc), the cross-sectional area of the cable can be appropriately increased.
6. Set breaker or fuse according to the below table.
7. Check that there is adequate voltage and current available at the heater connection to run the unit. Refer to the below table. Voltage ranges outside these parameters will damage the heat pump.

MODEL	NHX10	NHX11	NHX13	NHX14	NHX17	NHX18	NHX21	NHX22	NHX26	NHX32	NHX323	NHX403	
Breaker	Rated Current (A)	12.0	12.0	15.0	15.0	19.0	19.0	22.5	22.5	24.5	30.0	12.0	15.0
	Rated Residual Action Current (mA)	30	30	30	30	30	30	30	30	30	30	30	30
Max input current(A)	10.0	10.0	12.5	12.5	16.0	16.0	18.5	18.5	20.5	25.0	10.0	12.5	
Power Supply	230V 50Hz	230V 50Hz	230V 50Hz	230V 50Hz	230V 50Hz	230V 50Hz	230V 50Hz	230V 50Hz	230V 50Hz	230V 50Hz	230V 50Hz	400V 50Hz	400V 50Hz
Fuse (A)	12.0	12.0	15.0	15.0	19.0	19.0	22.5	22.5	24.5	30.0	12.0	15.0	
Power Cord (mm <sup>2</sup> )	3x2.5	3x2.5	3x2.5	3x2.5	3x2.5	3x2.5	3x2.5	3x2.5	3x4	3x6	5x2.5	5x2.5	
Signal cable (mm <sup>2</sup> )	3x0.5	3x0.5	3x0.5	3x0.5	3x0.5	3x0.5	3x0.5	3x0.5	3x0.5	3x0.5	3x0.5	3x0.5	

NOTE: The above data is adapted to a power cord length of  $\leq 5\text{m}$ . If power cord is  $>5\text{m}$ , wire diameter must be increased. The signal cable can be extended to 50m maximum.

8. Connect the power wiring according to the following information:

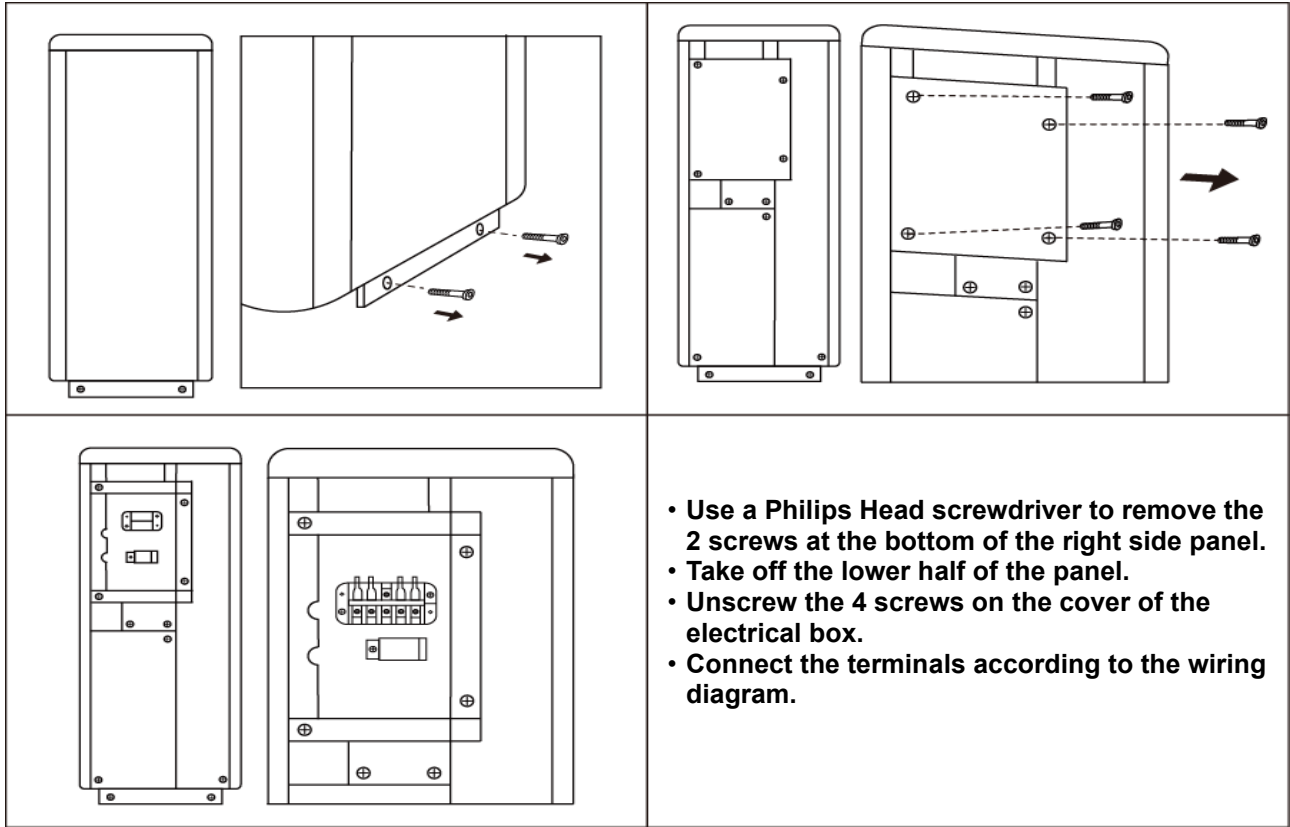

**5.6: WIRING DIAGRAM: SINGLE PHASE 230V 50Hz**

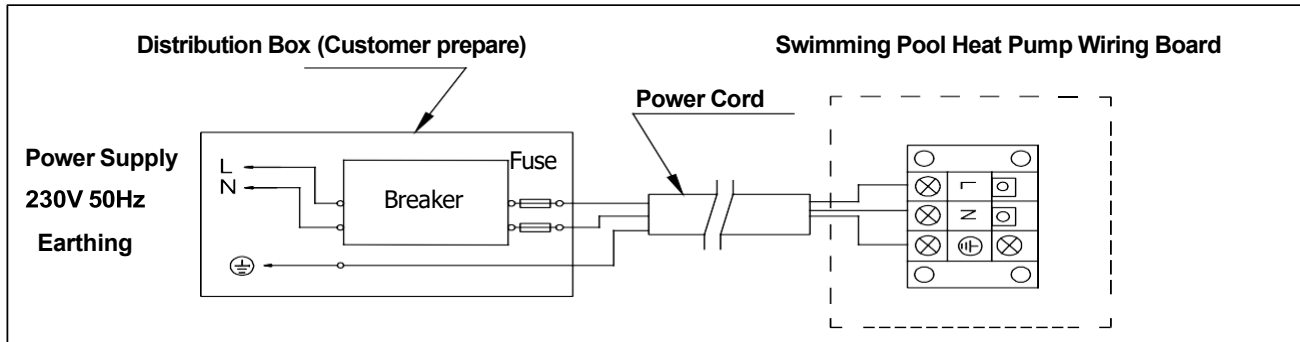

**5.7: WIRING DIAGRAM: 3 PHASE 400V 50Hz**

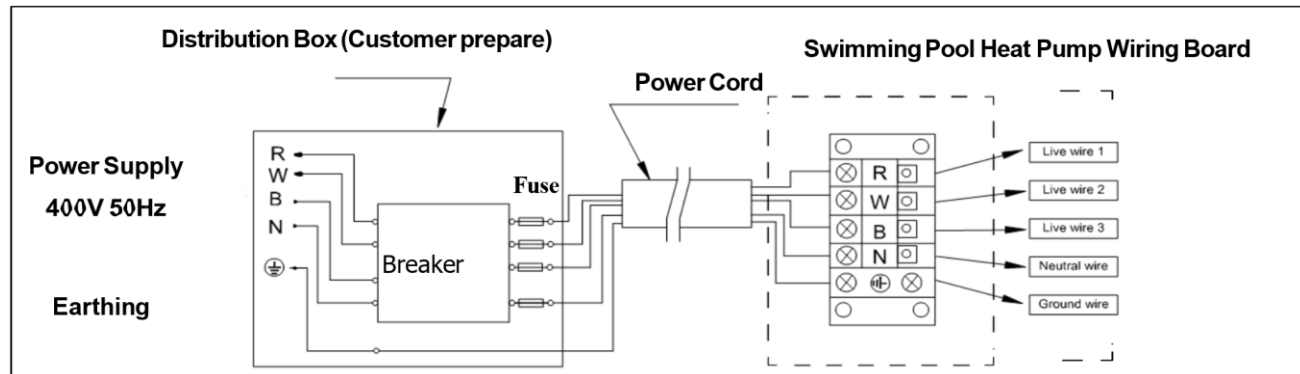

**5.8: WIRING DIAGRAM FOR EXTREME WINTER CONDITIONS: SINGLE PHASE 230V ≤500W**

Use this wiring diagram when installing a **SINGLE PHASE 230V ≤500W** heat pump in a location with extreme winter conditions (water freezing in pipes).

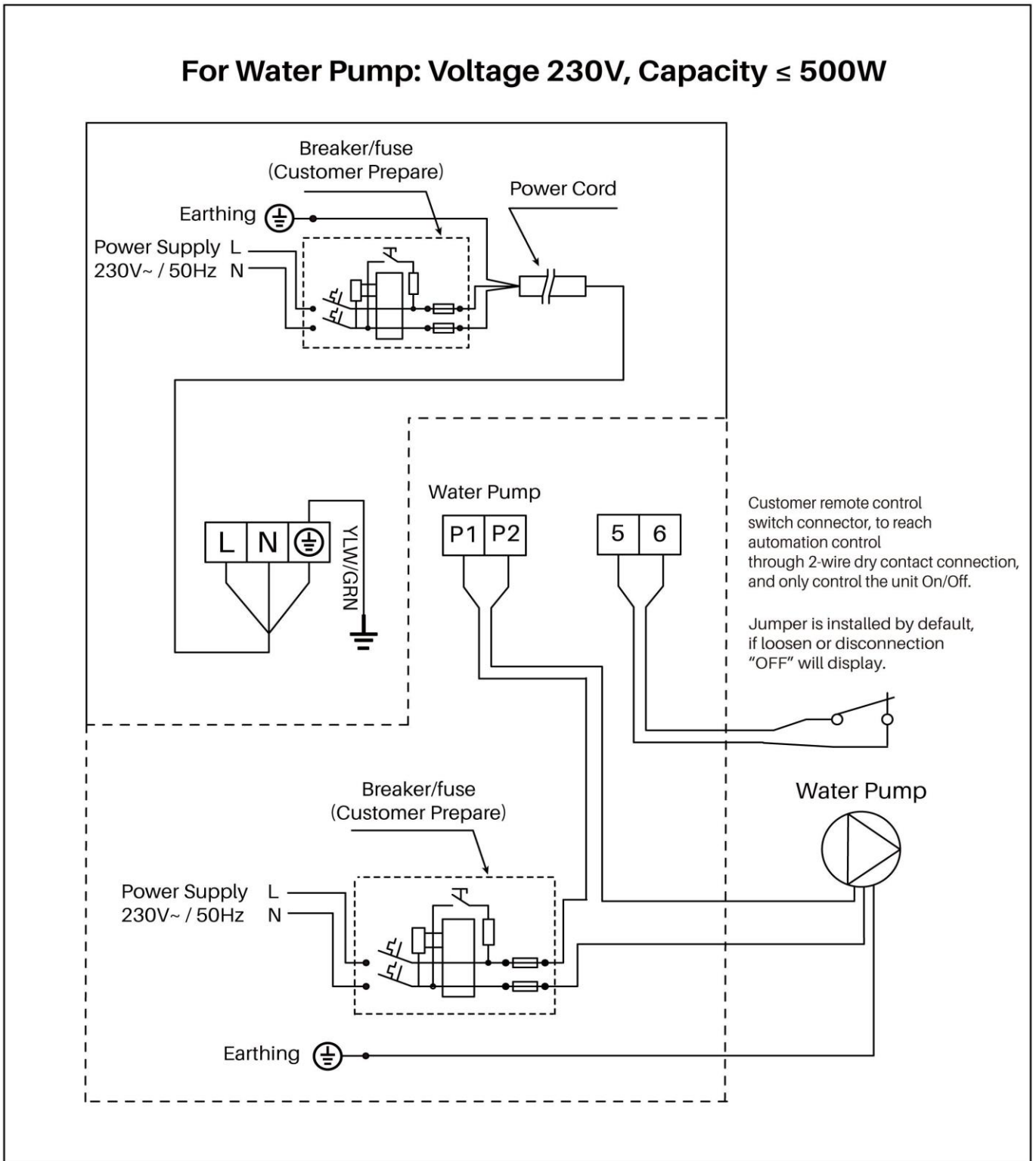

**5.9: WIRING DIAGRAM FOR EXTREME WINTER CONDITIONS: SINGLE PHASE 230V >500W**

Use this wiring diagram when installing a **SINGLE PHASE 230V >500W** heat pump in a location with extreme winter conditions (water freezing in pipes).

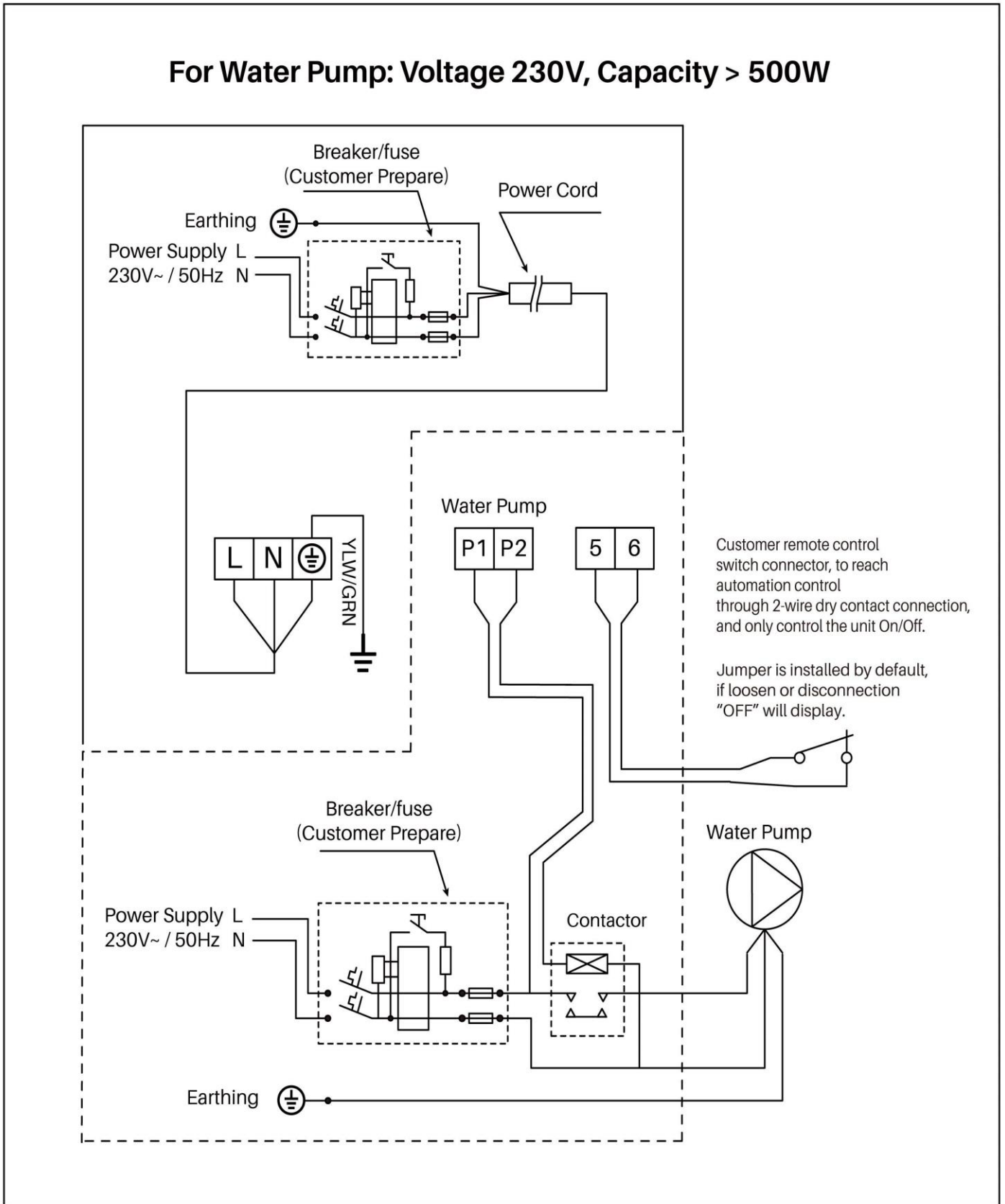



**5.10: WIRING DIAGRAM FOR EXTREME WINTER CONDITIONS: 3 PHASE 400V**

Use this wiring diagram when installing a **3 PHASE 400V** heat pump in a location with extreme winter conditions (water freezing in pipes).

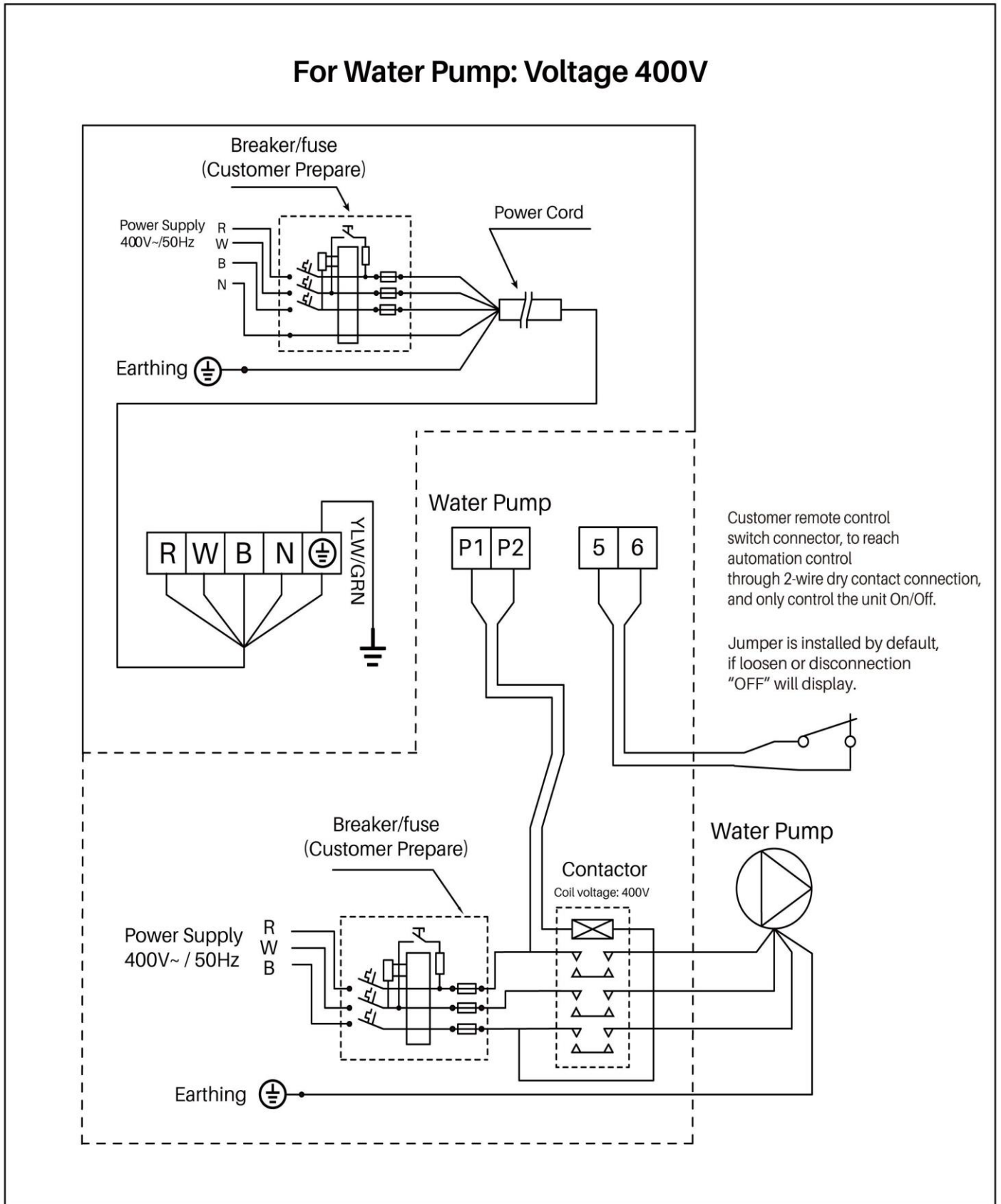

## 5.11: PARALLEL CONNECTION WITH FILTRATION CLOCK

A: Water pump timer

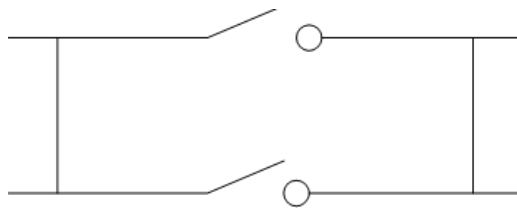

B: Water pump wiring of Heat Pump

Note: The installer should connect A parallel with B (as above picture). To start the water pump, condition A or B should be connected. To stop the water pump, both A and B should be disconnected.

## 5.12: CONNECTING THE NEPTUNE HEAT PUMP CONTROLLER

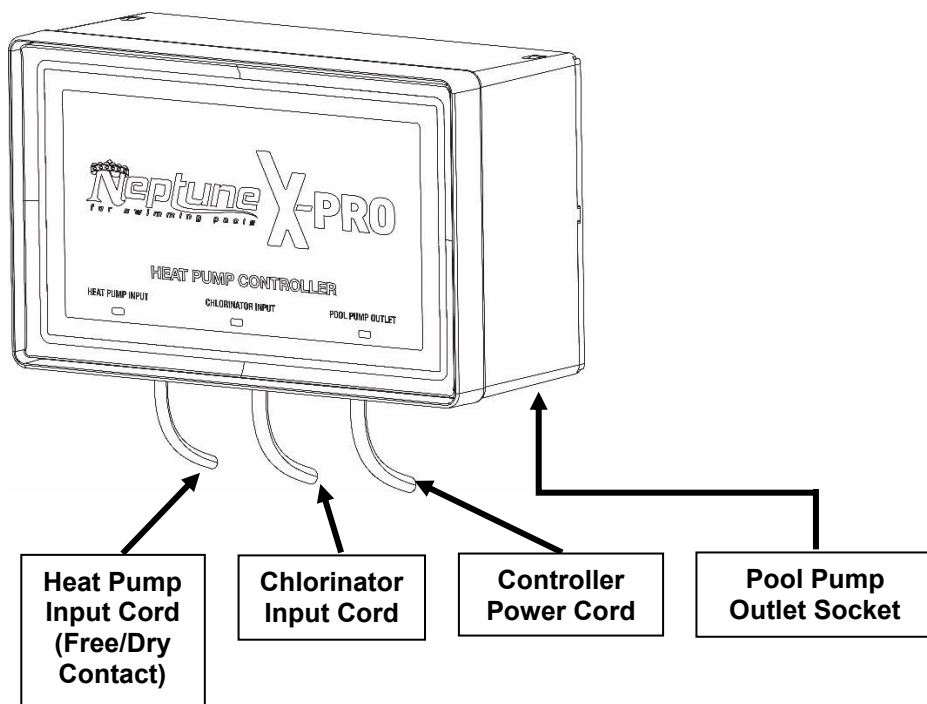

**Heat Pump Input Cord:** Connect this 2-pin terminal cable into the potential free dry contact on the Heat Pump (the P1 and P2 terminals located in the Electrical Box). This is a signal from the heat pump to turn the pool pump on. **See Pages 20 - 21 for instructions on how to access the Electrical Box.**

**Chlorinator Input Cord:** Fit this plug to the AC Socket outlet on the Chlorinator.

**Controller Power Cord:** Connect the Controller's power cord to a wall power socket. Don't forget to also plug your Chlorinator into a wall power socket.

**Pool Pump Outlet Socket:** Plug the power cord from the pool pump into this AC Socket underneath the controller.

\*\*\*For full installation instructions of this controller, refer to the Neptune Heat Pump Controller User Manual.

\*\*\*For other branded controllers please refer to their respective manuals. Most controllers will still connect to P1 and P2 terminals in the heat pump's Electrical Box.

1. Remove the 2 screws at the bottom of the panel that sits underneath the touchpad, then slide the panel down and remove it.

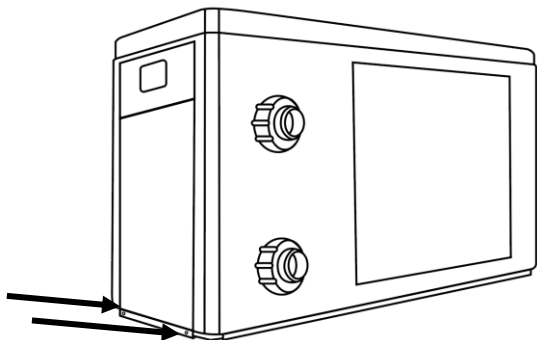

2. Remove the 4 screws from the electrical box.

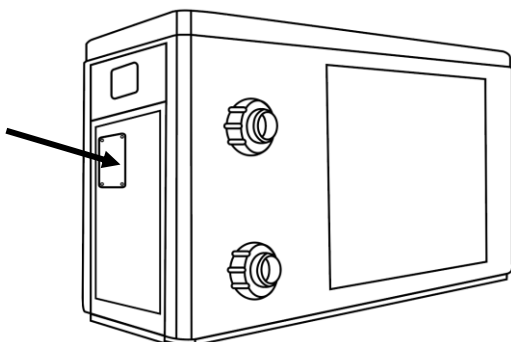

3. Thread the Neptune Heat Pump Controller's 2-pin cable through a vacant cable port, located near the heat pump's power cord.

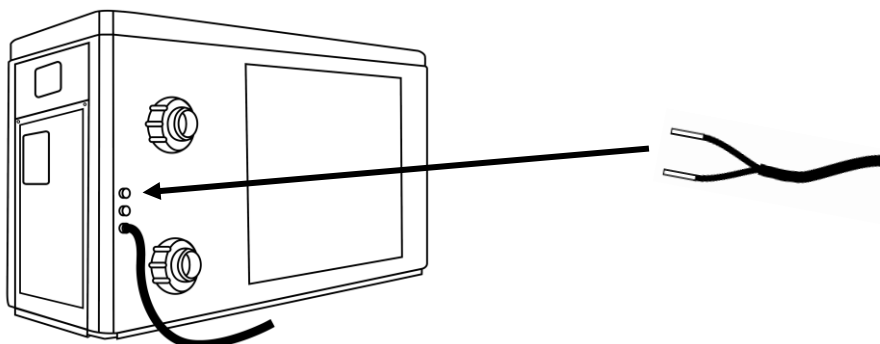

4. Continue threading the 2-pin cable up into the Electrical Box.

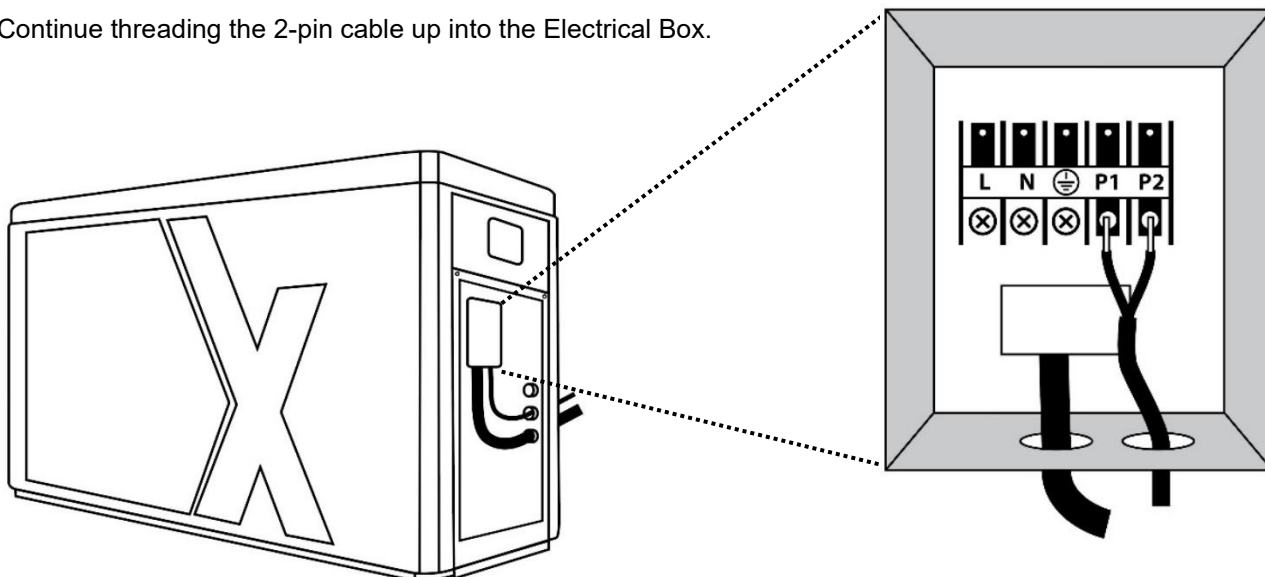



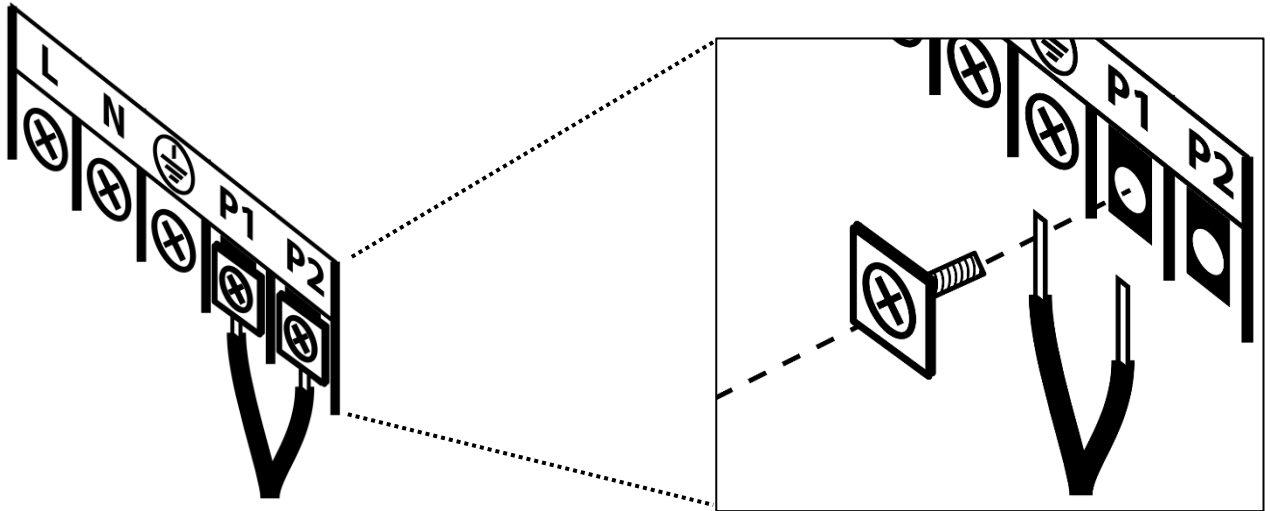



- Screw the Heat Pump Controller's 2-pin cable to the P1 and P2 Dry Contact connections inside the Electrical Box. Ensure the 2-pin cable wires are sandwiched between the screw plate and the contact plate.



- Re-attach all covers and panels.
- In order for the Heat Pump Controller to function, some settings in the heat pump are required to be changed. Changing these settings requires you to turn on the heat pump. Before turning on the heat pump, please run through all instructions in **Section 6: Initial Start-Up**, then return to the following steps.
- After following the initial start-up instructions in Section 6, ensure the heat pump is still on, and is displaying the main screen (example below).



- On the heat pump touchpad, press  for 3 seconds to unlock the screen (you will hear a beep when it unlocks).
- Press  and  together for 5 seconds to enter the "Parameter Checking" status screen. The parameter code "P0" and the parameter value "0" will display on the screen, e.g. "P0 0".
- Press  to enter the "Parameter Modification" mode.
- Press  two times to change the value from 0 to 2, then press  to save your changes.
- Press  to exit "Parameter Checking" status and return to the main screen.

**NOTES:**

"P0 0" means the heat pump will run the pool pump 24 hours a day.

"P0 2" means the heat pump will run the pool pump through the Heat Pump Controller. The heat pump will turn on for 3 minutes every hour to check the water temperature. If the water temperature is correct, the heat pump will turn off. If the water temperature needs to be adjusted, the heat pump will run until the water temperature is achieved, and then the heat pump, Heat Pump Controller, and pool pump will turn off.

## **SECTION 6: INITIAL START-UP**



Check all wirings carefully before turning on the heat pump.

### **6.1: PRE-STARTUP INSPECTION**

1. Check installation of the entire heat pump and the pipe connections according to the installation instructions in this manual.
2. Check the electrical wiring according to the electrical wiring diagram and earthing connection in this manual.
3. Ensure that the main power is connected properly.
4. Ensure there are no obstacle/blockages in front of the air inlet and outlet of the heat pump.

### **6.2: INITIAL STARTUP**

1. Ensure the 3-Way valve is fully open, then turn the pool pump on.
2. Check there are no water leaks and verify adequate flow to and from the pool.
3. As the heat pump is hardwired, turn on the isolation switch.
4. Press the Power symbol on the heat pump touchpad.
5. In order to protect the heat pump, the heat pump is equipped with a Delayed Start function. When starting the heat pump, the pool water pump will start to run for 3 minutes, then after another 30 seconds, the heat pump fan motor and compressor will start to run.
6. Check for any abnormal noises from the heat pump.
7. Check the air that is coming out of the heat pump fan, this air temperature should be 5°C-10°C cooler than the ambient air temperature.
8. Test the Flow Switch is working correctly. With the heat pump still running, turn the pool water pump off. If the Flow Switch is working, the heat pump should turn off automatically and the heat pump touchpad will display an error code E3 (insufficient water flow protection). Turn the pool water pump back on after testing the Flow Switch.
9. It is time to adjust the 3-Way valve and calibrate the flow rate though the heat pump. Fully close the 3-Way valve bypass and turn the heat pump to the maximum temperature.
10. Wait 3-4 minutes for the heat pump to run.
11. Check the difference in temperature between the inlet temperature and outlet temperature displayed on the heat pump's LCD screen.
12. Slowly open the 3-Way bypass valve to increase the temperature differential between the inlet and outlet. Closing the 3-Way bypass valve will decrease the temperature differential.
13. Adjust the 3-Way bypass valve until optimum differential of 2°C-3°C is achieved. Wait two minutes between each adjustment.
14. The 3-Way bypass valve is set up correctly when the temperature difference between the inlet and outlet is 2°C-3°C. Once this has been achieved, lock the position of the 3-Way bypass valve if possible.
15. The initial startup is complete. Choose your desired speed and temperature settings, and allow the heat pump to run 24 hours per day until the desired pool temperature is reached. This can take several days from a cold start.







## **SECTION 7: OPERATING INSTRUCTIONS**

### **7.1: IMPORTANT OPERATING INFORMATION**

- For the heat pump's ideal operating performance, the ideal ambient air temperature is 15°C-25°C.
- In case of power failure during the operation of the heat pump, the heat pump will automatically restart when the power is restored.
- Turn off the power during thunderstorms and severe weather.
- Do not use or store combustible gas or liquid such as thinners, paint or fuel near the heat pump.
- Always keep the heat pump in the upright position.
- The heat pump is designed for heating swimming pools; do not use it for any other purpose.
- The surroundings of the heat pump must be kept clear to avoid restricting ventilation.
- The heat pump must be kept away from any source of fire.
- Do not put anything into the inlet or outlet, and do not remove the fan cover.
- If any abnormal circumstances occur e.g. abnormal noises, smells, smoke and leakage of electricity, switch off the main power immediately and contact your authorised dealer.
- Do not try to repair the heat pump yourself or open the casing.
- To extend the life of your heat pump, ensure the pool water pump is on before starting the heat pump, and turn the pool water pump off after the heat pump is turned off.

## 7.2: HEAT PUMP TOUCHPAD OVERVIEW



Symbol	Designation	Function
	On/Off	<ol style="list-style-type: none"> <li>1. Power On/Off</li> <li>2. Wi-Fi setting</li> </ol>
 (This button will be lit up constantly when power is on)	Unlock / Mode	<ol style="list-style-type: none"> <li>1. Press for 3 seconds to unlock/lock screen</li> <li>2. After screen is unlocked, press it to select mode:                          Auto (12°C – 40°C)                          Heating (6°C – 40°C)                          Cooling (6°C – 30°C)</li> </ol>
	Speed	Select Turbo/Smart/Silence mode
	Up / Down	Adjust/set temperature
	Timer	Time and timer setting

### 7.3: HEAT PUMP LCD SCREEN OVERVIEW

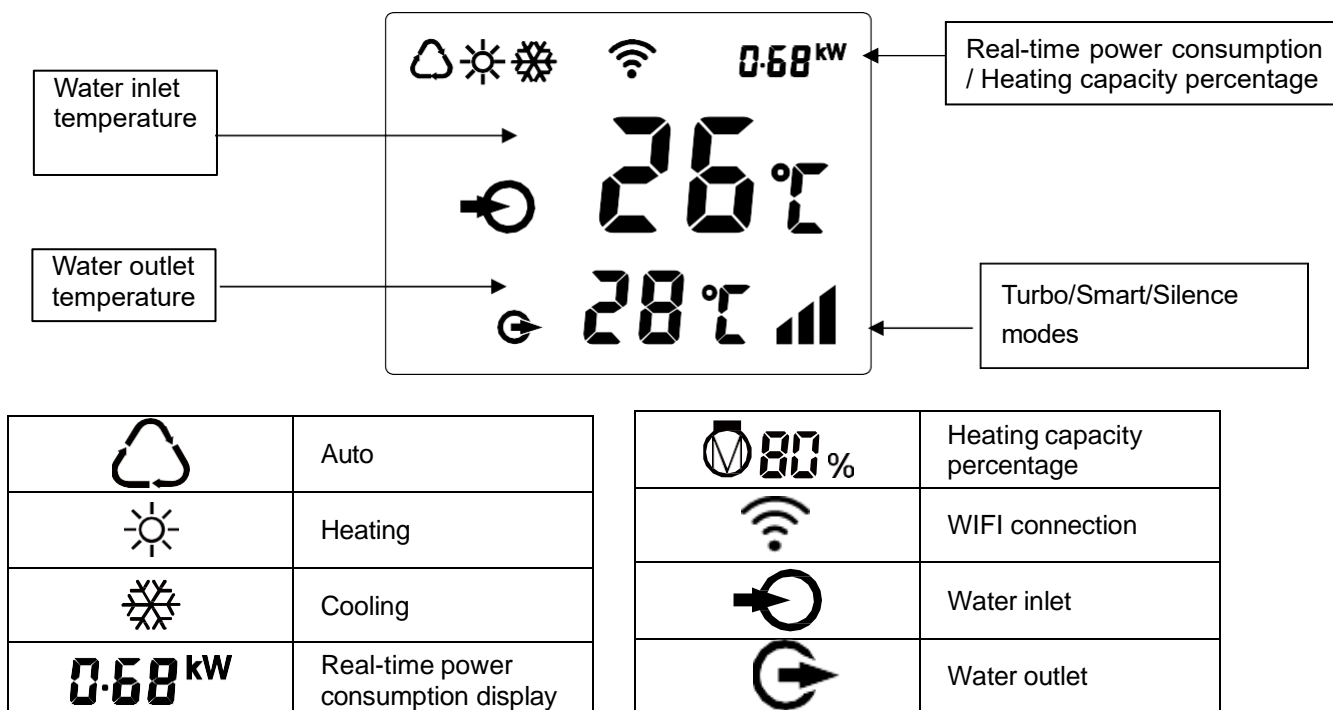

### 7.4: STANDBY MODE

- The LCD screen has a standby mode (screen lock) after no operation for 30 seconds. When in standby mode, the LCD screen will be dark and will only display the kW information.
- The LCD screen will go into standby mode if there is no touchpad operation for 30 seconds.
- Press for 3 seconds to either lock or unlock the screen. All other buttons on the touchpad will not be operational when the screen is locked.

### 7.5: TURNING ON THE HEAT PUMP

1. Ensure the 3-Way bypass valve is set up correctly (refer to Section 6.2).
2. Ensure the main power supply to the heat pump is on.
3. Power on the heat pump by pressing for 3 seconds to light up the LCD screen, then press to power on the heat pump.

### 7.6: SETTING THE TEMPERATURE



1. Ensure the LCD screen is unlocked. If the screen is dark, Press for 3 seconds to unlock the screen.
2. Press either or button once to display the current set temperature.
3. Continue to press or button to adjust the temperature.

### 7.7: SETTING THE HEATING/COOLING MODE

1. Ensure the LCD screen is unlocked. If the screen is dark, Press for 3 seconds to unlock the screen.
2. Press to select a mode:
  - Auto (12°C - 40°C)
  - Heating (6°C - 40°C)
  - Cooling (6°C - 30°C)





## 7.8: SETTING THE SPEED (TURBO/SMART/SILENCE MODE)



MODE	ADVANTAGES
Turbo mode 	<ul style="list-style-type: none"> <li>• Heating capacity: 120%~20%</li> <li>• Fast heating</li> </ul>
Smart mode 	<ul style="list-style-type: none"> <li>• Heating capacity: 100%~20%</li> <li>• Intelligent optimisation according to ambient temperature and water temperature</li> <li>• Energy efficient setting</li> </ul>
Silence mode 	<ul style="list-style-type: none"> <li>• Heating capacity: 60%~20%</li> <li>• Use at night</li> </ul>

1. Ensure the LCD screen is unlocked. If the screen is dark, Press  for 3 seconds to unlock the screen.

Press the  button to cycle through each mode:



**Smart Mode:** Smart mode is the default setting and will be activated when the heat pump is turned on. The  symbol will display on the LCD screen when the heat pump is set to Smart mode.

**Turbo Mode:** Press  button to enter Turbo mode. The  symbol will display on the LCD screen when the heat pump is set to Turbo mode.



**Silence Mode:** Press  button again to enter Silence mode. The  symbol will display on the LCD screen when the heat pump is set to Silence mode.

**NOTE:** Turbo mode can only be used when heating. Turbo mode will need to be selected each time you want to use it, as the default mode is Smart mode. During Turbo mode, when the machine reaches the set temperature, it will automatically return to Smart mode.

## 7.9: VIEWING REAL-TIME POWER CONSUMPTION OR COMPRESSOR PERCENTAGE







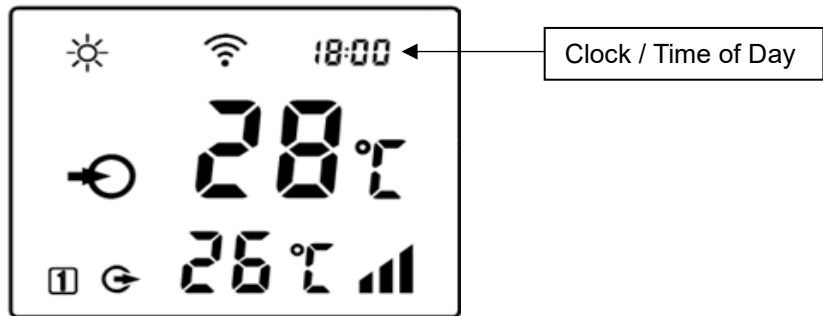

1. Ensure the LCD screen is unlocked. If the screen is dark, Press  for 3 seconds to unlock the screen.
2. To change between viewing the real-time power consumption (kW) and the compressor percentage, press the  and  buttons simultaneously for 5 seconds. Real-time power consumption function is available for single-phase only.

## 7.10: CHANGING TEMPERATURE BETWEEN °C AND °F

1. Ensure the LCD screen is unlocked. If the screen is dark, Press  for 3 seconds to unlock the screen.
2. Press  and  simultaneously for 5 seconds to switch between °C and °F.

### 7.11: SETTING THE CLOCK (TIME OF DAY)









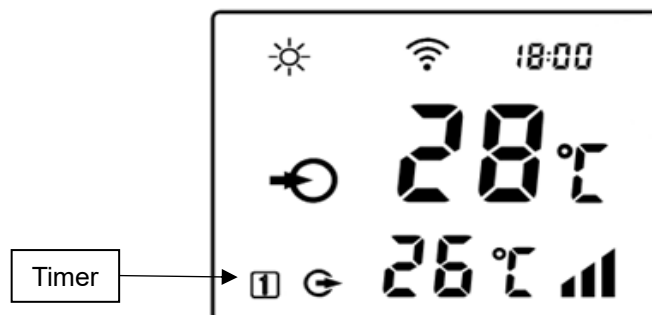

1. Ensure the LCD screen is unlocked. If the screen is dark, Press  for 3 seconds to unlock the screen.
2. Press  for 5 seconds, then the Hours will flash. Press  or  to adjust the Hour (in 24-hour format).
3. Press  to confirm the Hour setting, then the Minutes will flash. Press  or  to adjust the Minutes.
4. Press  to save your settings. If you need to cancel out of the clock setting at any time, press  once.



### 7.12: VIEWING THE TIME OF DAY



1. When the heat pump is off, the clock (time of day) will display on the LCD screen.
2. To view the time of day when the heat pump is on, press  once. The time of day will be displayed for 10 seconds.









### 7.13: SETTING THE TIMER (RUN TIMES OF THE HEAT PUMP)





1. Ensure the LCD screen is unlocked. If the screen is dark, Press  for 3 seconds to unlock the screen.
2. Check that the time of day has been set correctly – refer to Section 7.12. If time of day needs to be set, refer to Section 7.11.
3. To set the timer, press  for 10 seconds until you hear a beep, then the “Timer On” symbol  will flash on the screen.
4. The Hour will also flash. Press  or  to adjust the Hour that you want the heat pump to turn on (in 24-hour format).
5. Press  to confirm the Hour setting, then the Minute will flash. Press  or  to adjust the Minute that you want the heat pump to turn on.









6. Press  to save your settings. You have now set the timer to turn on ONCE ONLY. If you want the timer to REPEAT DAILY, now press  to activate the repeat function. The icon in the lower left corner of the LCD screen indicates:

	Timer on every day
	Timer on one time
<b>No symbol</b>	No Timer On setting

7. The “Timer Off” symbol  will now flash on the screen.
8. The Hour will also flash. Press  or  to adjust the Hour that you want the heat pump to turn off (in 24-hour format).
9. Press  to confirm the Hour setting, then the Minute will flash. Press  or  to adjust the Minute that you want the heat pump to turn off.
10. Press  to save your settings. You have now set the timer to turn off ONCE ONLY. If you want the timer to REPEAT DAILY, now press  to activate the repeat function.. The icon in the lower left corner of the LCD screen indicates:

	Timer off every day
	Timer off one time
<b>No symbol</b>	No Timer Off setting

11. Once you have set the on and off times, the icon/s in the lower left corner of the LCD screen indicates:

	Timer on every day	Timer off every day
	Timer on every day	Timer off one time
	Timer on every day	No timer off
	Timer on one time	Timer off every day
	No timer on	Timer off every day
	Timer on one time	Timer off one time
	Timer on one time	No timer off
	No timer on	Timer off one time
<b>No symbol</b>	No timer on	No timer off

## **7.14: DEFROSTING**

1. Auto Defrosting: When the heat pump is defrosting, ☀️ will flash. Once the defrosting function has finished, ☀️ will stop flashing.
2. Compulsory Defrosting: When the heat pump is heating, ensure the LCD screen is unlocked. If the screen is dark, Press 🔒 for 3 seconds to unlock the screen. Press 🌀 and ▼ simultaneously for 5 seconds to start compulsory defrosting. When the heat pump is defrosting, ☀️ will flash. Once the defrosting function has finished, ☀️ will stop flashing.

**NOTE:** Compulsory defrosting intervals should be more than 30 minutes and the compressor should run for more than 10 minutes.

## **7.15: USING THE HEAT PUMP COVER**

1. Ensure the heat pump is powered off and at ambient temperature.
2. Carefully fit the cover over the heat pump, and secure both straps at the inlet and outlet.
3. Remove the cover completely before turning on the heat pump.



## **SECTION 8: WIFI SETUP**

### **8.1: APP DOWNLOAD AND ACCOUNT REGISTRATION**

1. Ensure your mobile device is connected to WIFI. On your mobile device, download the “Inverter life” app in the Apple iOS App Store or the Google Play Store.

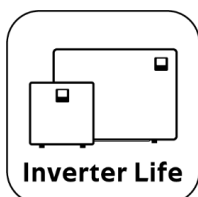

2. Create an account in the Inverter Life app. Ensure you allow the app to access devices on your local network, and access Notifications, Bluetooth and WIFI.

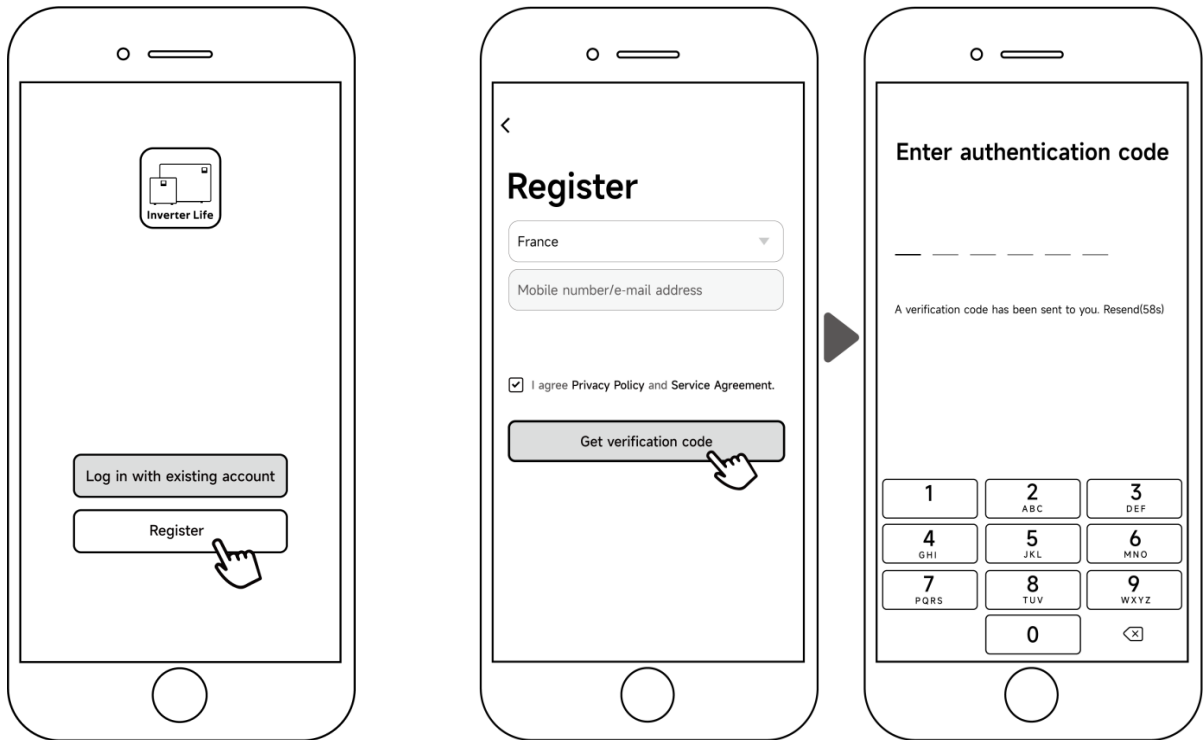

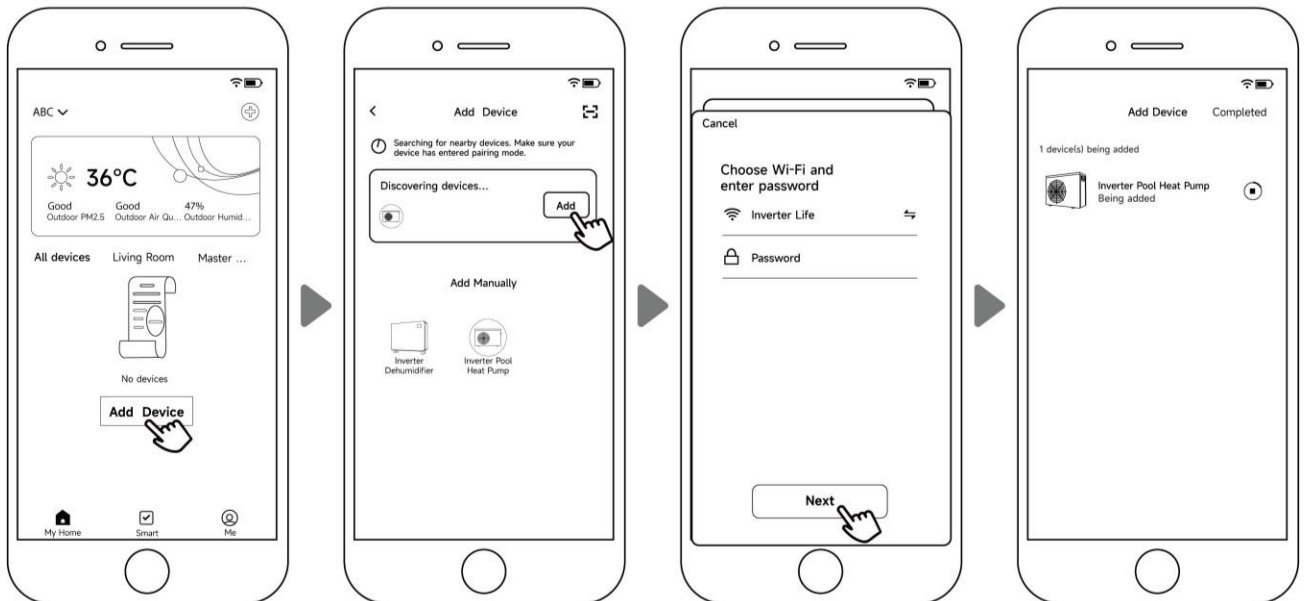

## **8.2: PAIRING YOUR DEVICE WITH THE HEAT PUMP VIA AUTO-DISCOVERY/BLUETOOTH**

1. To begin connecting your heat pump with the app, press  on the heat pump for 3 seconds after the screen is unlocked.  will flash to indicate it has entered pairing mode.
2. Tap on the “add device” button in the Inverter Life app (please allow Location Services). The app will automatically search for available devices. Follow the below steps to finish pairing.



### 8.3: PAIRING YOUR DEVICE WITH THE HEAT PUMP VIA MANUALLY ADDING

1. To begin connecting your heat pump with the app, press  on the heat pump for 3 seconds after the screen is unlocked.  will flash to indicate it has entered pairing mode.
2. Tap on the “add device” button in the Inverter Life app (please allow Location Services). Add the device manually by following the below steps.

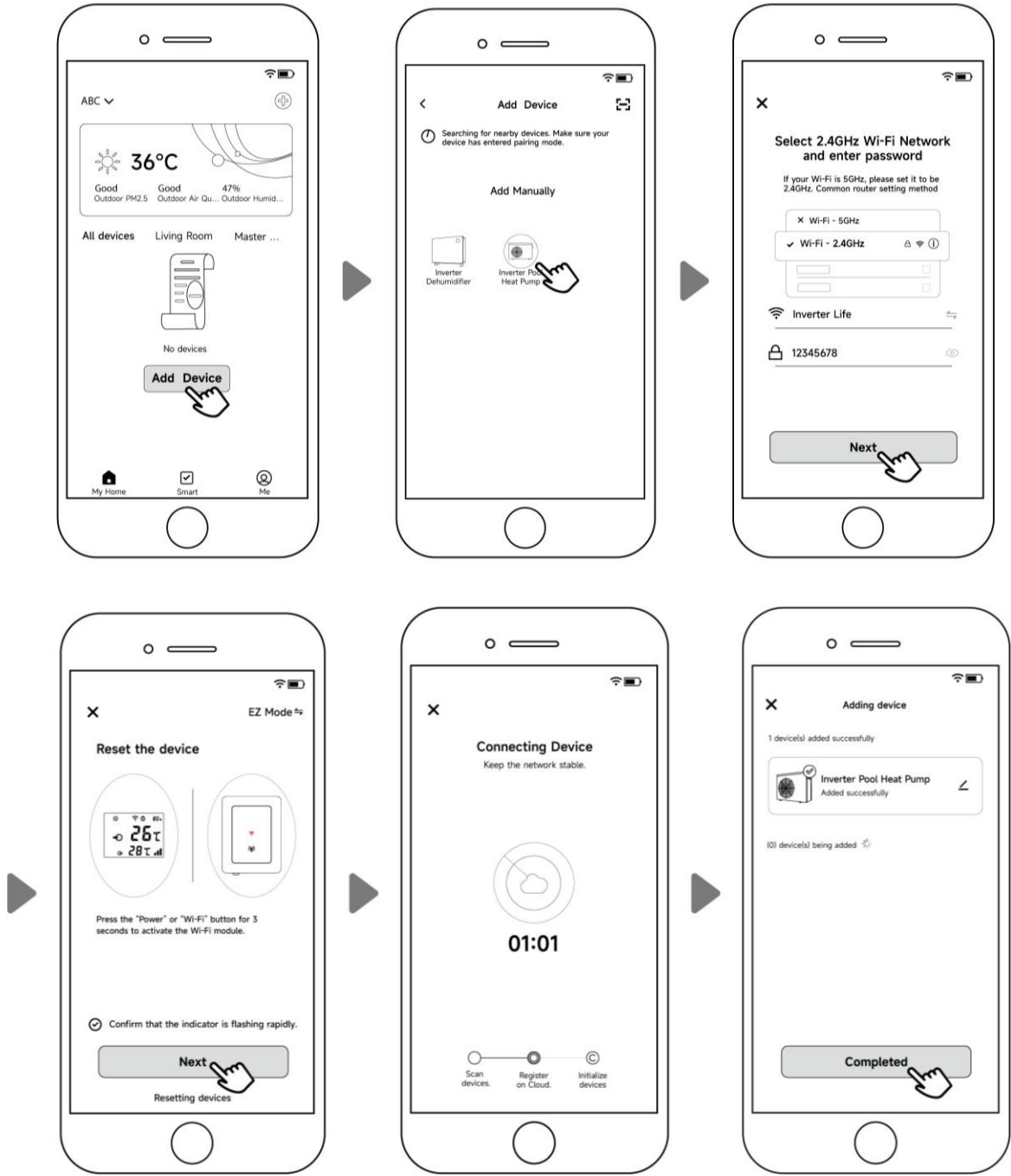

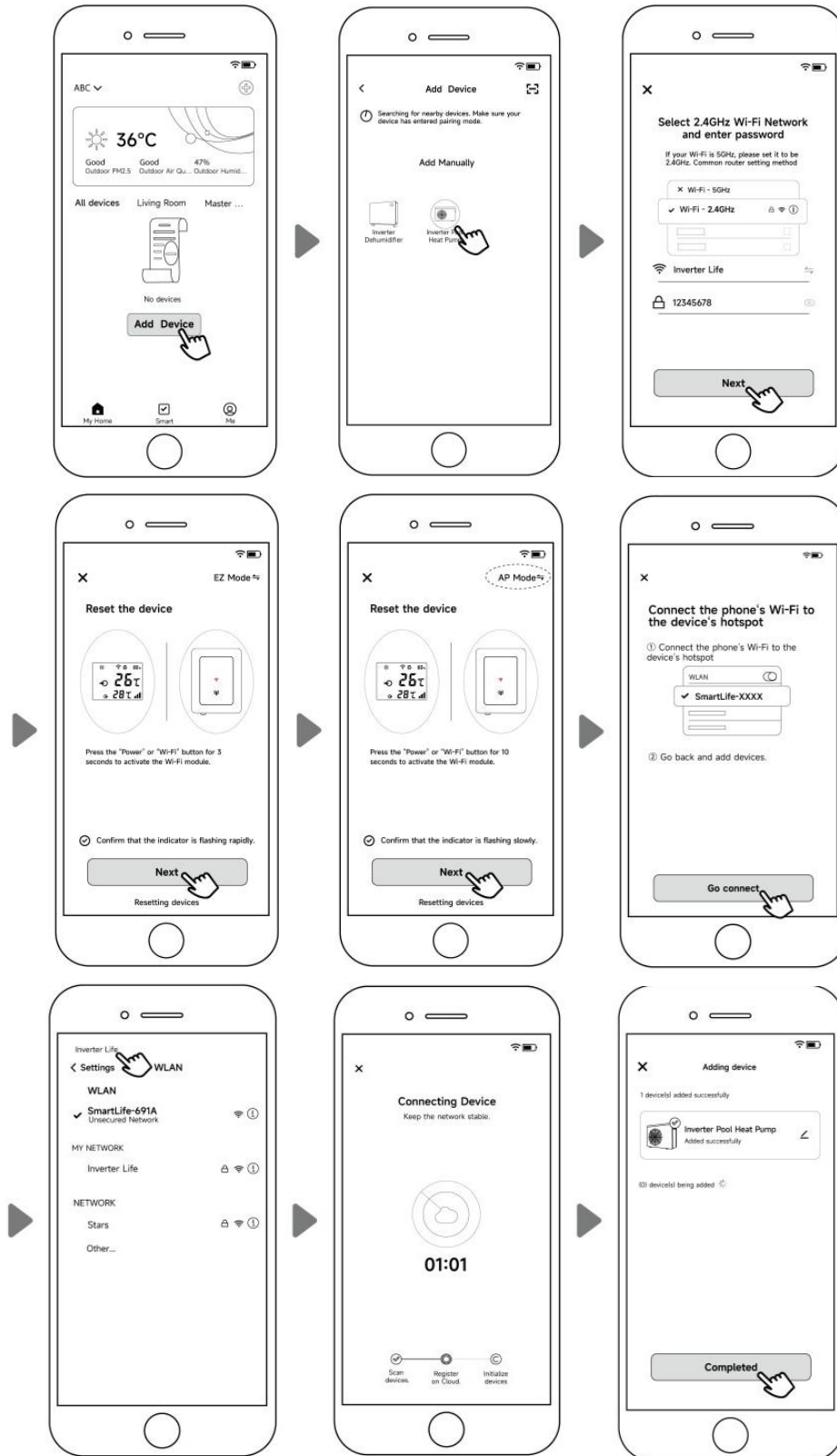

## 8.4: PAIRING YOUR DEVICE WITH THE HEAT PUMP VIA AP MODE

- To begin connecting your heat pump with the app, press  on the heat pump for 3 seconds after the screen is unlocked.  will flash to indicate it has entered pairing mode.
- Tap on the “add device” button in the Inverter Life app (please allow Location Services). Add the device via AP Mode by following the below steps.



### 8.5: RE-PAIRING YOUR DEVICE

You may experience a pairing failure if your WIFI password changes or your network configuration changes. To re-pair your mobile device to your heat pump, follow these steps.

1. Ensure your network name and password are correct.
2. Ensure your router, mobile phone and device are as close as possible.
3. Press  on your heat pump for 10 seconds.  will flash slowly for 60 seconds then  will turn off – this has removed your original pairing. Follow any of the steps in 8.2, 8.3 or 8.4 to re-pair your device.

NOTE: Ensure your router is configured at 2.5GHz.

### 8.6: APP FEATURES

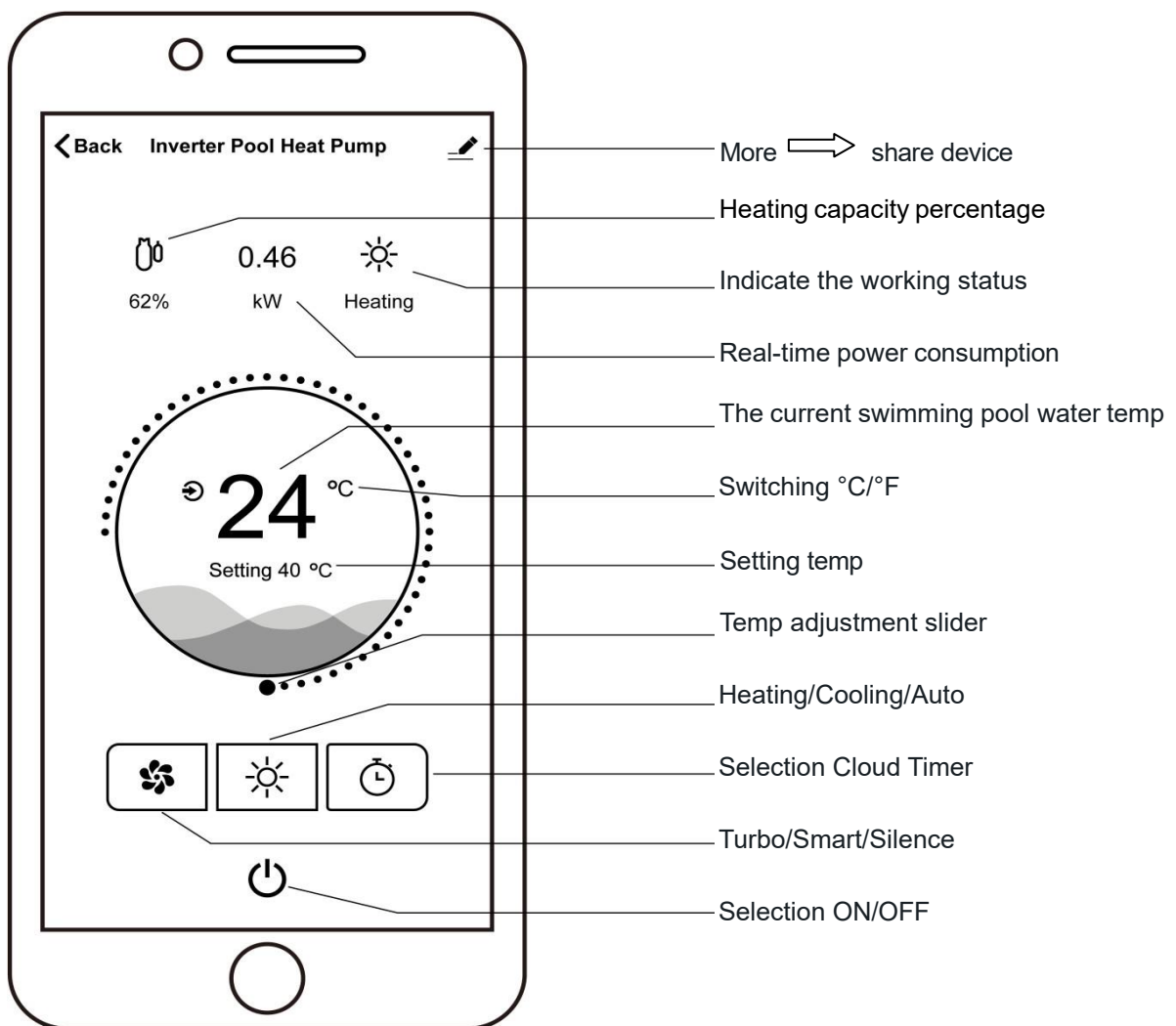



## 8.7: SHARE DEVICES WITH FAMILY MEMBERS

After you have paired your mobile device with the heat pump, you can share it with other family members.

1. Ensure other family member's device has downloaded/installed the app, and has registered their account in the app (refer to Section 8.1).
2. As the Administrator, tap on More, then tap on Shared Devices. Allow sharing by following the below steps.

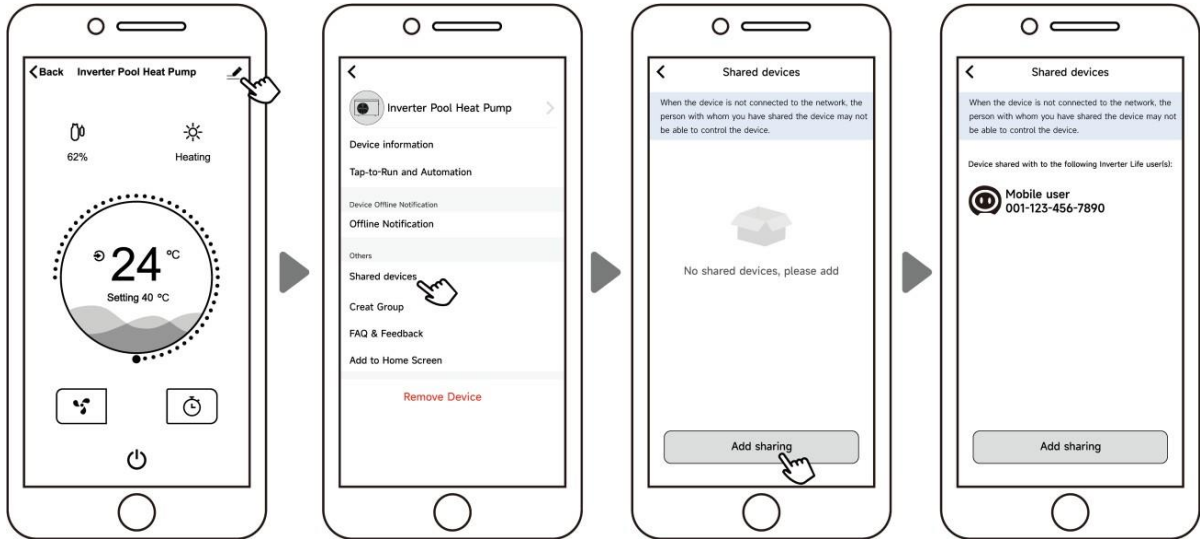

3. Your family member should now be able to see the heat pump in their app.
4. If you'd like more than 1 family member to connect to the same device, you can create a Family in your app.

## 8.8: CREATE A FAMILY

After you have paired your mobile device with the heat pump, you can share it with other family members.

1. Tap on your profile "Me" in the app, then tap on Home Management.
2. Tap on Add Family. Fill in the details and tap Save.

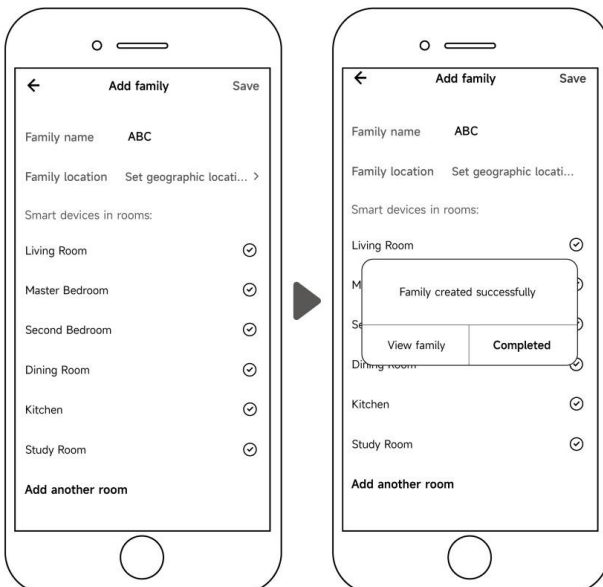

3. Other family members who have the Inverter Life app set up on their mobile device (refer to Section 8.1) can now tap Join a Home to be linked to your Family setup.

## **SECTION 9: MAINTENANCE**

### **9.1: REGULAR MAINTENANCE**

**!** Regular maintenance can be carried out by the user.

1. Regularly check there are no obstacles blocking the air inlet and outlet of the heat pump.
2. Regularly check all unions, bolts and other visible connections for leaks or signs of wear.

### **9.2: ANNUAL MAINTENANCE – QUALIFIED TECHNICIAN ONLY**

**!** Annual maintenance must be carried out by a qualified professional technician.

1. Turn off the main power supply of the heat pump before cleaning, examination and repairing. Do not touch the electronic components until the LED indication lights on the PC board turn off.

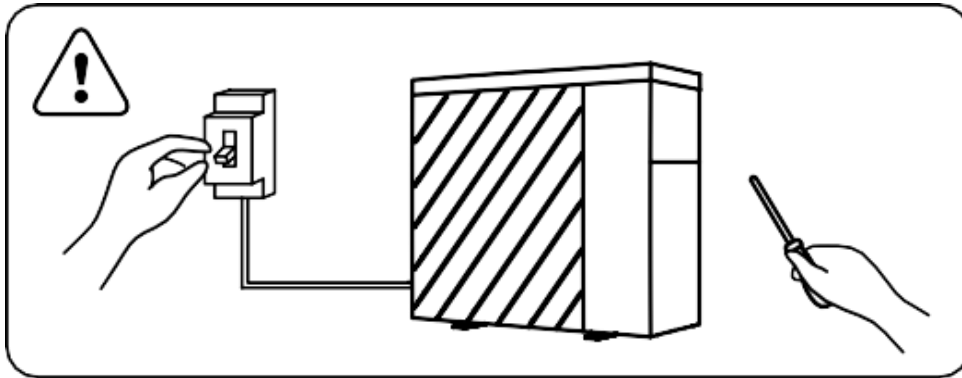

2. Clean the evaporator with household detergents or clean water. NEVER use gasoline, thinners or any similar fuel.
3. Check bolts, cables and connections are in good condition.
4. If any spare parts are required, contact your authorised dealer. Only use genuine spare parts.
5. Only qualified professional technicians must handle/refill gas.

## **SECTION 10: WINTERISING**

**!** Do not allow water to freeze inside the heat pump, as this may damage the titanium heat exchanger and void your warranty.

**!** When using the heat pump under 2°C, make sure there is always water flow.

Follow these steps when the heat pump will not be used for an extended period of time e.g. Winter.

1. Turn off the main power supply to the heat pump.

2. Fully close the 3-way valve.

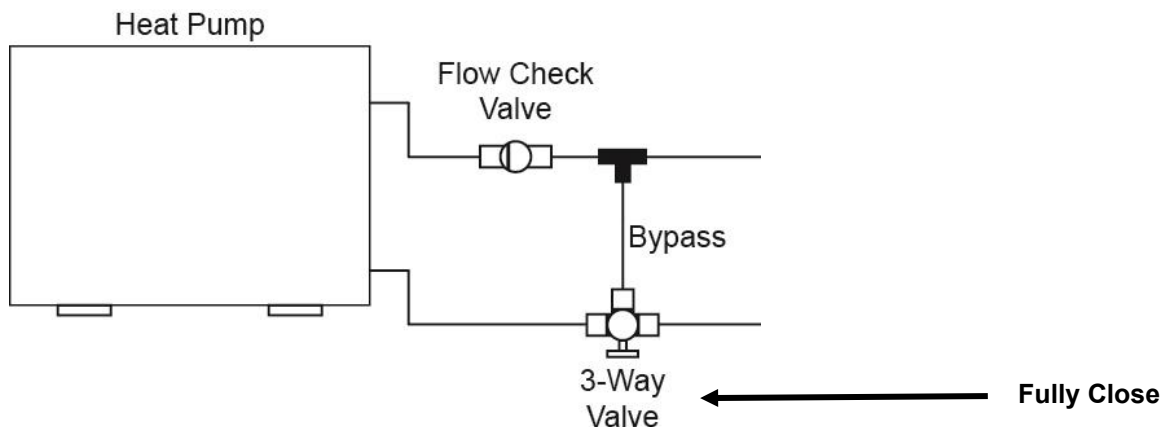

3. Drain the water out of the heat pump by unscrewing the lower union (inlet) and let the water run out.

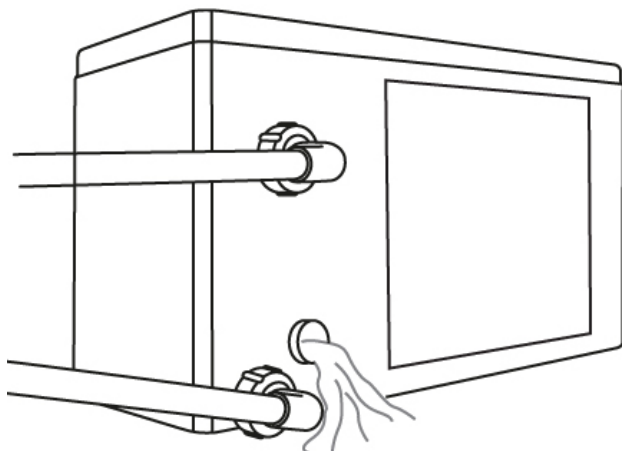

4. Screw the inlet union securely back into place.
5. When you are ready to resume operation of your heat pump, perform all steps in Section 6 to ensure the heat pump is set up correctly.

## **SECTION 11: TROUBLESHOOTING**

ISSUE	POSSIBLE REASON	POSSIBLE SOLUTION
Heat pump doesn't run	No power	Wait until the power recovers
	Power switch is off	Switch on the power
	Fuse burned	Check and change the circuit fuse in your power box
	The breaker is off	Check and turn on the breaker
Fan is running but with insufficient heating	Evaporator blocked	Remove the obstacles
	Air outlet blocked	Remove the obstacles
	3 minutes start delay	Wait patiently
Display normal, but no heating	Set temp. too low	Set proper heating temperature
	3 minutes start delay	Wait patiently
If the above solutions don't work, please contact your installer with detailed information and your model number. Do not try to repair it yourself.		

DISPLAY	DESCRIPTION
E3	No water protection/no water flow
E5	Power supply exceeds operation range
E6	Excessive temp difference between inlet and outlet water (insufficient water flow protection)
Eb	Ambient temperature too high or too low protection
Ed	Anti-freezing reminder
E1	High pressure protection
E2	Low pressure protection
E4	Phases lack protection (three phase models only)
E7	Water outlet temp too high or too low protection
E8	High exhaust temp protection
EA	Evaporator overheat protection (only at cooling mode)
P0	Controller communication failure
P1	Water inlet temp sensor failure
P2	Water outlet temp sensor failure
P3	Gas exhaust temp sensor failure
P4	Heating (Evaporator) coil pipe temp sensor
P5	Gas return temp sensor failure
P6	Cooling (Titanium heat exchanger) coil pipe temp sensor
P7	Ambient temp sensor failure
P8	Cooling plate sensor failure
P9	Current sensor failure
PA	Restart memory failure
F1	Compressor drive module failure
F2	PFC module failure
F3	Compressor start failure
F4	Compressor running failure
F5	Inverter board over current protection
F6	Inverter board overheat protection
F7	Current protection
F8	Cooling plate overheat protection
F9	Fan motor failure
Fb	Capacitor no charging protection
FA	PFC module over current protection

**SECTION 12: SCHEMATICS – NHX10, NHX11, NHX13, NHX14, NHX17, NHX18, NHX21, NHX22, NHX26, NHX32**

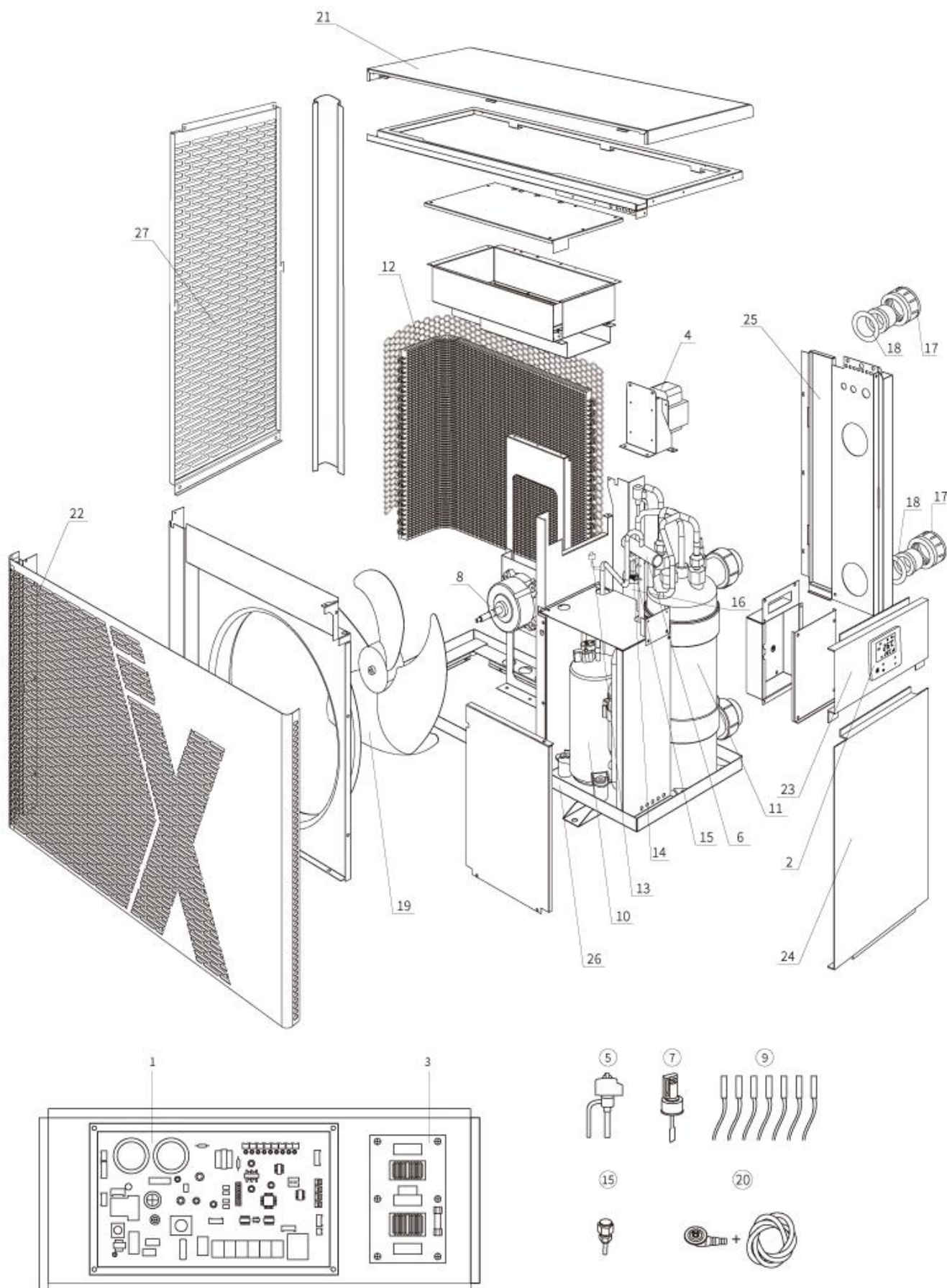

**MODELS NHX10, NHX11, NHX13, NHX14, NHX17, NHX18, NHX21, NHX22, NHX26, NHX32**

Ref #	Stock Code	DESCRIPTION
1	NHXP001	Integrated board for NHX10 & NHX11
1	NHXP002	Integrated board for NHX13 & NHX14
1	NHXP003	Integrated board for NHX17 & NHX18
1	NHXP004	Integrated board for NHX21 & NHX22
1	NHXP005	Integrated board for NHX26
1	NHXP006	Integrated board for NHX32
2	NHXP025	Touch controller
3	NHXP015	Power filter plate for NHX10 & NHX11
3	NHXP016	Power filter plate for NHX13, NHX14, NHX17 & NHX18
3	NHXP017	Power filter plate for NHX21 & NHX22
3	NHXP018	Power filter plate for NHX26 & NHX32
4	NHXP340	Reactor (big) for NHX10 & NHX11
4	NHXP341	Reactor (big) for NHX13 & NHX14
4	NHXP342	Reactor (big) for NHX17, NHX18, NHX21 & NHX22
4	NHXP343	Reactor (big) for 26 & NHX32
5	NHXP250	Electronic expansion valve for NHX10, NHX11, NHX13, NHX14, NHX17 & NHX18
5	NHXP251	Electronic expansion valve for NHX21 & NHX22
5	NHXP252	Electronic expansion valve for NHX26
5	NHXP253	Electronic expansion valve for NHX32
6	NHXP210	4-way valve for NHX10, NHX11, NHX13, NHX14, NHX17 & NHX18
6	NHXP211	4-way valve for NHX21 & NHX22
6	NHXP212	4-way valve for NHX26 & NHX32
7	NHXP020	Water flow switch
8	NHXP030	Fan motor for NHX10 & NHX11
8	NHXP031	Fan motor for NHX13, NHX14, NHX17, NHX18, NHX21 & NHX22
8	NHXP032	Fan motor for NHX26 & NHX32
9	NHXP040	Full set of sensors
10	NHXP230	Compressor for NHX10 & NHX11
10	NHXP231	Compressor for NHX13, NHX14, NHX17 & NHX18
10	NHXP232	Compressor for NHX21 & NHX22
10	NHXP233	Compressor for NHX26
10	NHXP234	Compressor for NHX32
11	NHXP360	Titanium heat exchanger (Heat) for NHX10 & NHX11
11	NHXP361	Titanium heat exchanger (Heat) for NHX13 & NHX14
11	NHXP362	Titanium heat exchanger (Heat) for NHX17 & NHX18
11	NHXP363	Titanium heat exchanger (Heat) for NHX21 & NHX22
11	NHXP365	Titanium heat exchanger (Heat) for NHX26
11	NHXP367	Titanium heat exchanger (Heat) for NHX32
12	TBA	Evaporator
13	NHXP280	High pressure protection switch
14	NHXP050	Low pressure protection switch
15	NHXP060	Low Pressure valve
16	TBA	Liquid reservoir (only for models NHX26 & NHX32)
17	NHXP070	Water union
18	NHXP080	Water union gasket
19	NHXP090	Fan for NHX10 & NHX11
19	NHXP091	Fan for NHX13, NHX14, NHX17 & NHX18
19	NHXP092	Fan for NHX21 & NHX22
19	NHXP093	Fan for NHX26 & NHX32
20	NHXP100	Drainage kit for NHX10, NHX11, NHX13, NHX14, NHX17, NHX18, NHX21, NHX22, NHX26 & NHX32
21	TBA	Top cover
22	TBA	Front Panel
23	TBA	Right Upper Panel
24	TBA	Right Lower Panel
25	TBA	Back Panel
26	TBA	Bottom board
27	TBA	Left mesh board
-	NHXP270	Foot (New Style) w/ Bolt Assembly 4pk

\* Contact Pool Pro for any parts without a listed code.

# SECTION 13: SCHEMATICS – NHX323, NHX403

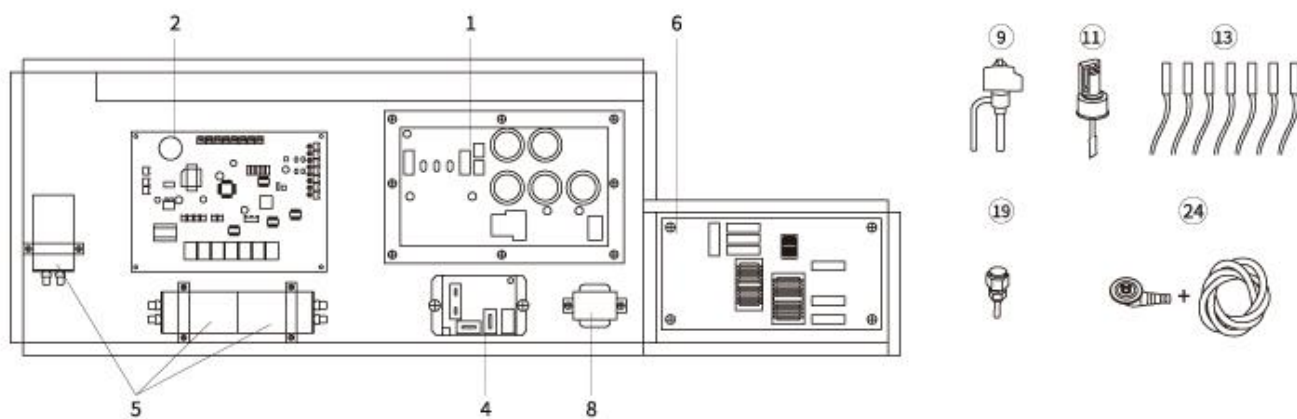
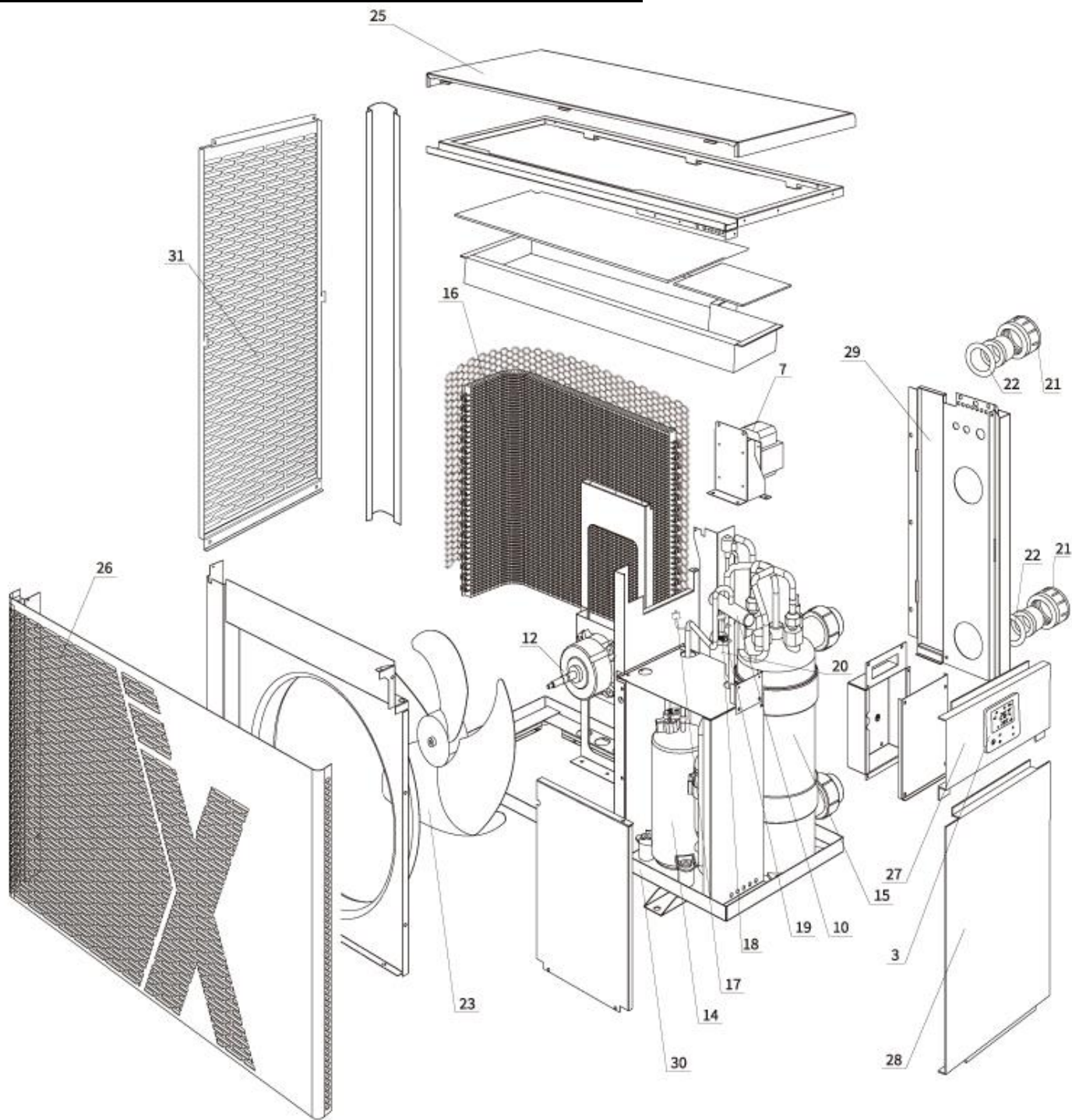

## MODELS NHX323, NHX403

Ref #	Stock Code	DESCRIPTION
1	NHXP317	Inverter board
2	NHXP325	PC board (Heat) for NHX323
2	NHXP328	PC board (Heat) for NHX403
3	NHXP025	Touch controller for NHX323 & NHX403
4	TBA	Contactora (3 phase relay)
5	NHXP225	Capacitor (3 phase) for NHX323
5	NHXP227	Capacitor (3 phase) for NHX403
6	NHXP019	Power filter plate for NHX323 & NHX403
7	NHXP344	Reactor (big) for NHX323
7	NHXP345	Reactor (big) for NHX403
8	NHXP351	Reactor (small)
9	NHXP253	Electronic expansion valve
10	NHXP212	4-way valve
11	NHXP020	Water flow switch for NHX323 & NHX403
12	NHXP032	Fan motor for NHX323 & NHX403
13	NHXP040	Full set of sensors for NHX323 & NHX403
14	NHXP234	Compressor
15	NHXP367	Titanium heat exchanger (Heat)
16	TBA	Evaporator
17	NHXP280	High pressure protection switch
18	NHXP050	Low pressure protection switch for NHX323 & NHX403
19	NHXP060	Low Pressure valve for NHX323 & NHX403
20	TBA	Liquid reservoir
21	NHXP070	Water union for NHX323 & NHX403
22	NHXP080	Water union gasket for NHX323 & NHX403
23	NHXP093	Fan for NHX323 & NHX403
24	NHXP100	Drainage kit for NHX323 & NHX403
25	TBA	Top cover
26	TBA	Front Panel
27	TBA	Right Upper Panel
28	TBA	Right Lower Panel
29	TBA	Back Panel
30	TBA	Bottom board
31	TBA	Left mesh board
-	NHXP270	Foot (New Style) w/ Bolt Assembly 4pk

\* Contact Pool Pro for any parts without a listed code.



## **SECTION 14: WARRANTY & PRODUCT REGISTRATION**

Please register your product online at [www.poolpro.com.au/product-registration](http://www.poolpro.com.au/product-registration) within 30 days from date of purchase, or any warranty claim may be voided.

- The warranty for the Neptune X-Pro Heat Pump (models NHX10, NHX11, NHX13, NHX14, NHX17, NHX18, NHX21, NHX22, NHX26, NHX32, NHX323, NHX403, NHX10TD, NHX11TD, NHX13TD, NHX17TD, NHX21TD, NHX26TD, NHX32TD, NHX32TD3, NHX40TD3) covers manufacturer's defects in materials and workmanship for:

25 years on the heat exchanger  
10 years on the compressor  
5 years on all other parts  
1 year on labour

If the heat pump is installed in a commercial setting, the warranty periods are 25 years on the heat exchanger, 5 years on the compressor, 2 years on all other parts, 1 year on labour.

- The warranty is only valid for the original purchaser and is non-transferable.
- Adverse operating conditions beyond the control of the manufacturer such as improper voltage, excessive ambient temperature or any condition that adversely affects the performance of the equipment will render this warranty null and void.
- Defective equipment must be returned to the authorised dealer as soon as the purchaser becomes aware of the defect and all transport costs must be prepaid.
- Neither the manufacturer nor the authorised dealer shall be responsible for any goods damaged in transit.
- Any liability of the manufacturer pursuant to the Trade Practices Act 1974, as amended for a breach of a condition or warranty shall be limited to replacing or acquiring the equipment (or part thereof) where the same has been supplied.
- The maximum liability incurred by the manufacturer shall not in any case exceed the contract price for the equipment or the product parts or components thereof claimed to be defective. Further, the manufacturer shall not be liable for any loss, damage or delay directly or indirectly caused by any malfunction of or defect of or failure of the equipment other than as expressly provided in this warranty.
- The manufacturer and authorised dealer will not be held liable for damage caused to the pool and surrounding areas.
- Keep your original purchase invoice and serial number in a safe place.

Warranty is void under the following circumstances:

- Incorrect operation of the unit by not following correct instructions.
- Improper maintenance and balancing of pool water.
- Damage caused to the heat pump due to misuse or damage caused by any other means than manufacturer defect.
- If the heat pump is repaired or serviced by an unauthorised dealer or serviceman.
- If a fault occurs in the operation of the heat pump by using non-genuine parts/accessories.
- If the heat pump has been misused, neglected, damaged or altered in any way.
- General wear and tear of consumable products.

To submit a warranty request, visit [www.poolpro.com.au/serviceclaim](http://www.poolpro.com.au/serviceclaim)

